

QUMI

User Manual

Preface

Copyright

©2013 Vivitek Corporation. **vivitek**[®] is a trademark of Vivitek Corporation. Other trademarks are the properties of their respective owners. Values, weights and dimensions are approximate. Specifications are subject to change without prior notice.

Disclaimer

The information in this document is subject to change without notice. The manufacturer makes no representations or warranties with respect to the contents hereof and specifically disclaims any implied warranties of merchantability or fitness for any particular purpose. The manufacturer reserves the right to revise this publication and to make changes from time to time in the content hereof without obligation of the manufacturer to notify any person of such revision or changes.

Trademark Recognition



Kensington is a U.S. registered trademark of ACCO Brand Corporation with issued registrations and pending applications in other countries throughout the world.



HDMI, the HDMI Logo, and High-Definition Multimedia Interface are trademarks or registered trademarks of HDMI Licensing LLC in the United States and other countries.



MHL, the MHL logo, and Mobile High-Definition Link are trademarks or registered trademarks of MHL licensing, LLC.

All other product names used in this manual are the properties of their respective owners and are acknowledged.



Important Safety Information

Important:

It is strongly recommended that you read this section carefully before using the Qumi. These safety and usage instructions that will make sure you enjoy many years of safe use of the Qumi. Keep this manual for future reference.

Symbols Used

Warning symbols are used on the unit and in this manual to alert you of hazardous situations.

The following styles are used in this manual to alert you to important information.

Note:

Provides additional information on the topic at hand.

Important:

Provides additional information that should not be overlooked.

Caution:

Alerts you to situations that may damage the unit.

Warning:

Alerts you to situations that may damage the unit, create a hazardous environment, or cause personal injury.

Throughout this manual, component parts and items in the OSD (On-Screen Display) menus are denoted in bold font as in this example:

“Press the **Menu** button on the remote control to open the **Main** menu.”

General Safety Information

- Do not open the unit case. There are no user-serviceable parts in the unit. For servicing, contact qualified service personnel.
- Follow all warnings and cautions in this manual and on the unit case.
- The projection light source is extremely bright by design. To avoid damage to eyes, do not look into the lens when the LED illumination is on.
- Do not place the unit on an unstable surface or stand.
- Avoid using the system near water, in direct sunlight, or near a heating device.
- Do not place heavy objects such as books or bags on the unit.



Qumi Installation Notice

- Allow at least a 50cm clearance around the exhaust vent.

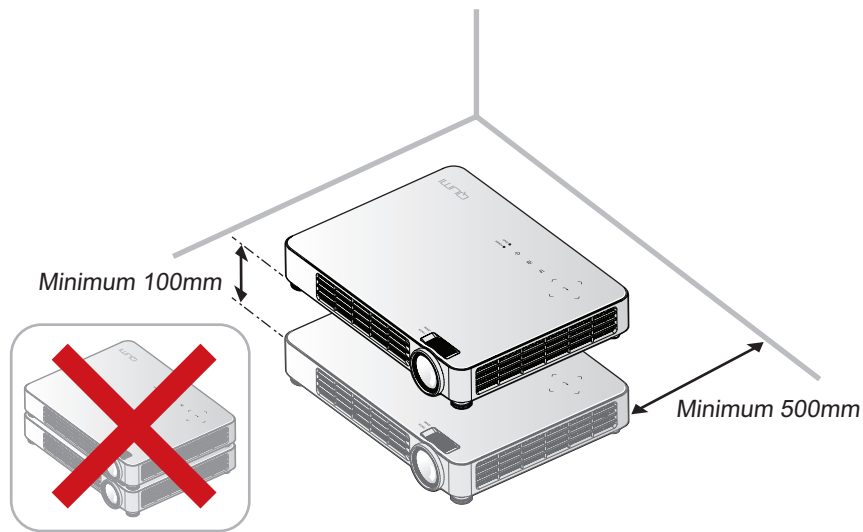

- Make sure that the intake vents do not recycle hot air from the exhaust vent.
- When operating the Qumi in an enclosed space, make sure that the surrounding air temperature within the enclosure does not exceed operating temperature while the Qumi is running, and the air intake and exhaust vents are unobstructed.
- All enclosures should pass a certified thermal evaluation to make sure that the Qumi does not recycle exhaust air, as this may cause the device to shutdown even if the enclosure temperature is within the acceptable operating temperature range.

Caution:

Avoid using the Qumi in dusty environments.



Power Safety

- Only use the supplied power cord.
- Do not place anything on the cord. Place the cord where it will not be in the way of foot traffic.
- Remove the battery from the remote control when storing or not in use for a prolonged period.

Cleaning the Qumi

- Unplug the cord before cleaning. See *Cleaning the Qumi* on page 45.

Note:

The Qumi will be warm after usage. Allow Qumi to cool down before storing in a compartment.

Regulatory Warnings

Before installing and using the Qumi, read the regulatory notices in the *Regulatory Compliance* on page 57.

Symbol Explanations



DISPOSAL: Do not use household or municipal waste collection services for disposal of electrical and electronic equipment. EU countries require the use of separate recycling collection services.

Main Features

- Lightweight unit, easy to pack away and transport.
- Compatible with all major video standards including NTSC, PAL, and SECAM.
- A high brightness rating allows for presentations in daylight or in lit rooms.
- Supports data resolution up to UXGA at 16.7 million colors to deliver crisp, clear images.
- Flexible setup allows for front, rear, ceiling and rear ceiling projections.
- Line-of-vision projections remain square, with advanced keystone correction for angled projections.
- Input source automatically detected.

About this manual

This manual is intended for end users and describes how to install and operate the Qumi. Wherever possible, relevant information—such as an illustration and its description—has been kept on one page. This printer-friendly format is both for your convenience and to help save paper, thereby protecting the environment. It is suggested that you only print sections that are relevant to your needs.



Table of Contents

| | |
|--|-----------|
| Preface | ii |
| Chapter 1 At a Glance | 1 |
| Overview | 1 |
| Accessories | 3 |
| Remote Control..... | 4 |
| Qumi and Remote Control Buttons..... | 4 |
| Media Player Screen | 5 |
| Chapter 2 Getting Started..... | 6 |
| What You Need..... | 6 |
| Setting Up Qumi | 7 |
| Setting Up the Remote Control..... | 13 |
| Chapter 3 Qumi Media Suite..... | 14 |
| Overview..... | 14 |
| Music | 15 |
| Movies | 17 |
| Photos..... | 18 |
| Office Viewer..... | 19 |
| Wifi | 20 |
| Web browser..... | 23 |
| Wifi Display | 24 |
| Settings..... | 25 |
| Chapter 4 On-Screen Display (OSD) Settings..... | 27 |
| OSD Menu Controls..... | 27 |
| Setting the OSD Language..... | 28 |
| OSD Menu Overview | 29 |
| Image Menu | 30 |
| Settings 1 Menu..... | 34 |
| Settings 2 Menu..... | 39 |
| Chapter 5 Taking Care of Your Qumi..... | 45 |
| Cleaning the Qumi..... | 45 |
| Cleaning the Lens..... | 45 |
| Troubleshooting | 46 |
| Vivitek Support Site..... | 50 |
| Specifications..... | 51 |
| Projection Distance vs. Projection Size | 52 |
| Projection Distance and Size Table | 52 |
| Timing Mode Table..... | 53 |
| 2D→3D Timing Table | 54 |
| 3D Timing Table | 55 |
| Qumi Dimensions | 56 |
| Regulatory Compliance | 57 |
| Safety Certifications..... | 57 |
| Disposal and Recycling | 57 |



Chapter 1 At a Glance

Overview

Front/Top/Right View

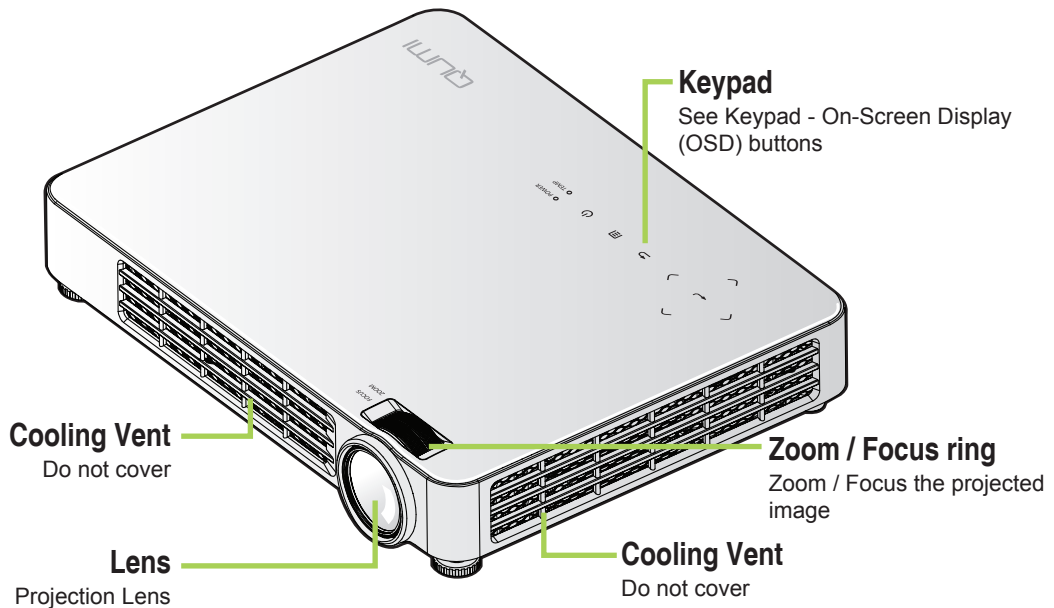

Keypad

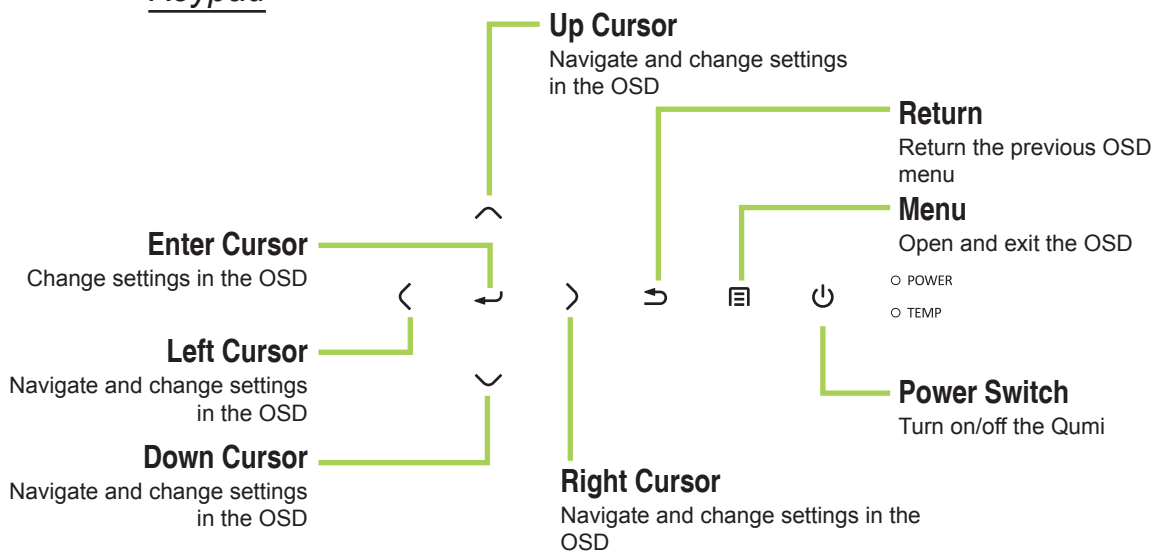

Rear/Top/Left View

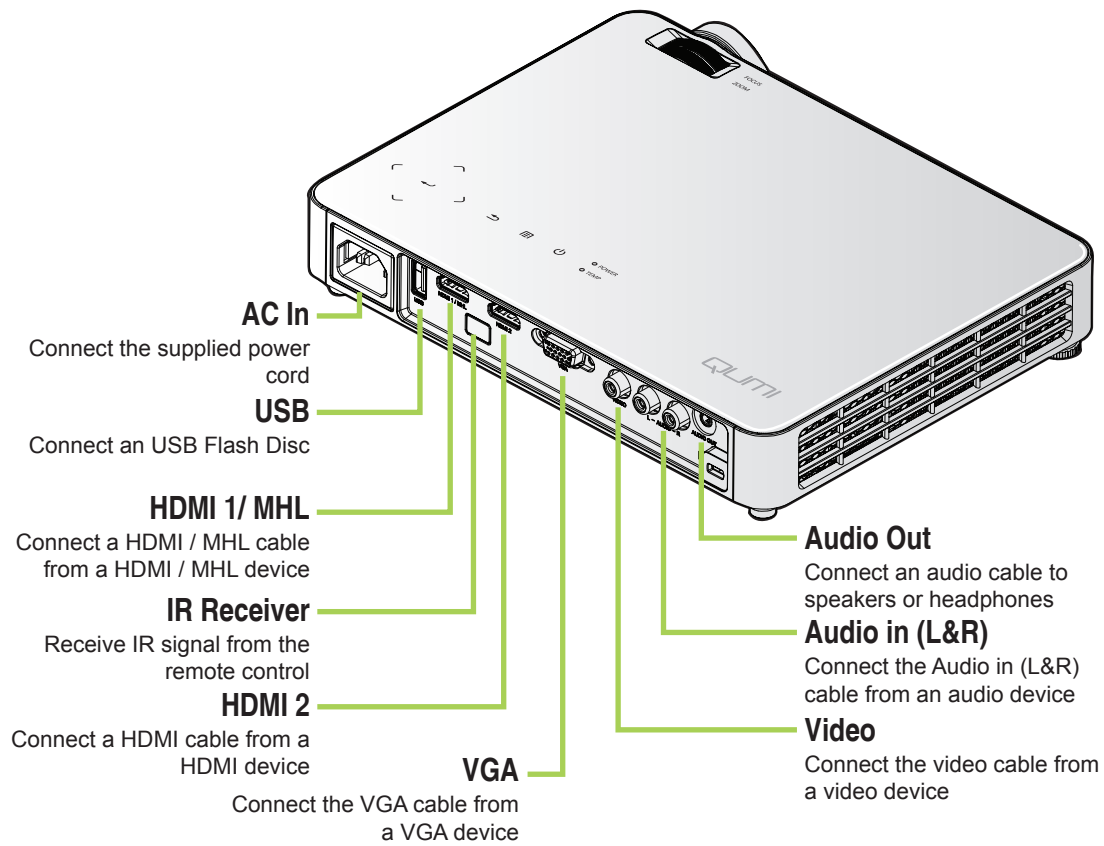

Bottom View

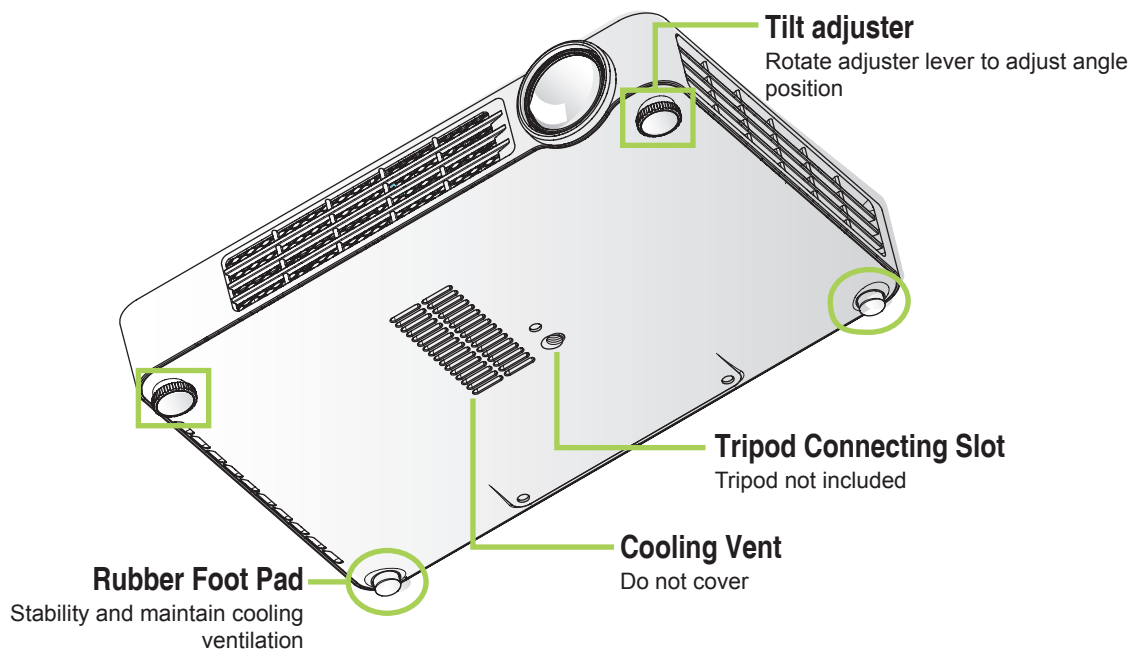

Accessories

Along with the Qumi, the following accessories are included:



Remote Control
(With one 3V CR2025 battery)



Standard HDMI Cable



VGA Cable

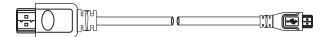

MHL cable



Regional Power Cord



Documentation Kit
(User Manual, Quick Start Guide, Warranty Card)



Carrying Case



Lens Cap

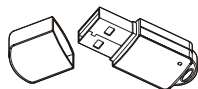

WiFi Dongle (Optional)

Contact your dealer immediately if any items are missing, appear damaged, or if the unit does not work. It is recommended that you keep the original packing material should you ever need to return the equipment for warranty service.

Note:

Accessories will vary from model to model.



Remote Control

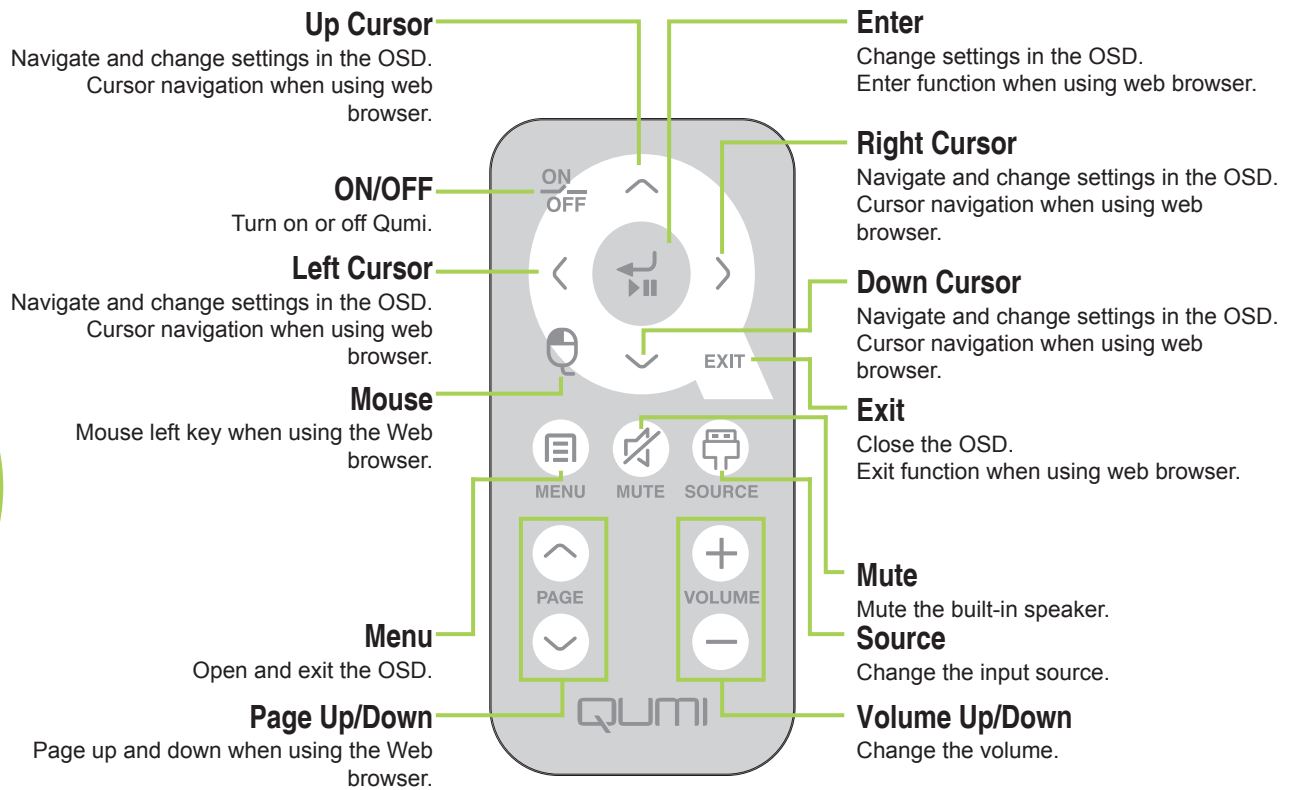

Important:

1. Be sure nothing obstructs the path between the remote control and the Qumi. If the path between the remote control and the Qumi is obstructed, the signal can bounce off certain reflective surfaces.
2. The buttons and keys on the Qumi have the same layout and similar functions as the corresponding buttons on the remote control. This user's manual describes the functions based on the remote control.

Qumi and Remote Control Buttons

The Qumi can be operated using the remote control or the keypad on the top of the Qumi. All operations can be carried out with the remote control; however, the keypad on the Qumi carries out the same operations as the remote control by pressing a combination of keys.

The remote control is not only used to navigate the cursor in the menus, but can also be used to control the media functions (music and video playback). For more details about how to control the media functions with the remote control, please refer to 14.

Media Player Screen

The media player screen is the main interface for the Qumi Q7 Series. If a USB Flash Disc is plugged in when powering on the Qumi, the media player screen appears. In the media player screen, you can choose the type of media to display by selecting:

- Music – A music player that supports many types of audio files, ready to play music.
- Movie – An easy to use movie player that displays multiple movie formats.
- Photo – A photo viewer that contains slide show functionality.
- Office viewer – A document viewer that displays documents.
- Wifi Display – Use this to configure the connection to a wireless access point.
- Web browser – A Web browser for surfing the Internet.
- Wifi – Use this to choose a Wi-Fi access point.
- Settings – The settings of the Qumi can be adjusted in this menu.

Note:

Wifi & Web browser functions are only available with Q7's dongle.



Chapter 2 Getting Started

What You Need

Many types of external devices and peripherals can be connected to the Qumi. External or portable music players can be connected to play music. DVD, VCD and VHS players can be connected to play movies. Camcorders and digital cameras can also be used to play videos and display photos. Computers can be connected, as well as peripherals such as USB Flash Disc to display documents and other types of media.

These devices can be connected to the Qumi by using an appropriate cable. Make sure that the connecting device has an appropriate output connector.

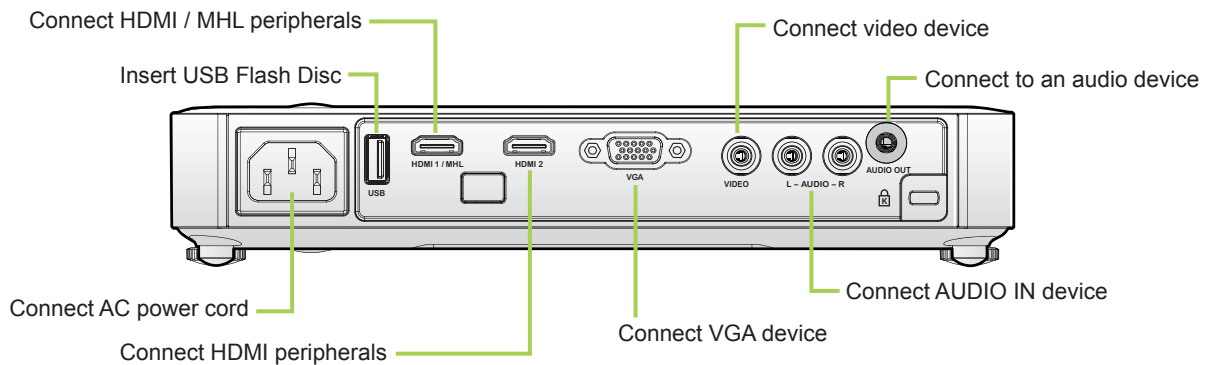

Warning:

As a safety precaution, disconnect all power to the Qumi and connecting devices before making connections.

Setting Up Qumi

Connecting to an HDMI Device

Connect your Qumi to an HDMI device by using an HDMI cable.

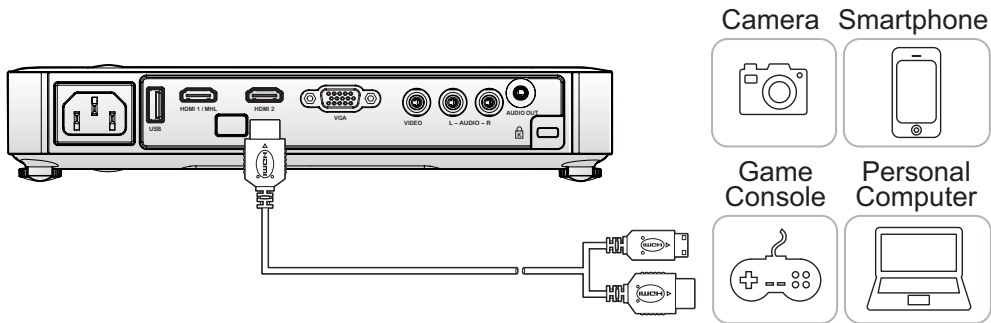

Connecting to an MHL Device

Connect your Qumi to a MHL-compatible device by using an MHL cable.

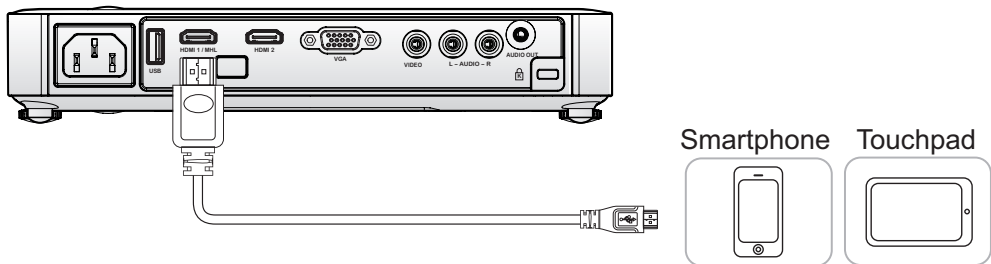

Note:

For some MHL compatible devices, whose output is not thru micro-USB, an extra cable adaptor may be required.

Connecting to a Personal Computer

Connect your Qumi to a personal computer by using a VGA cable.

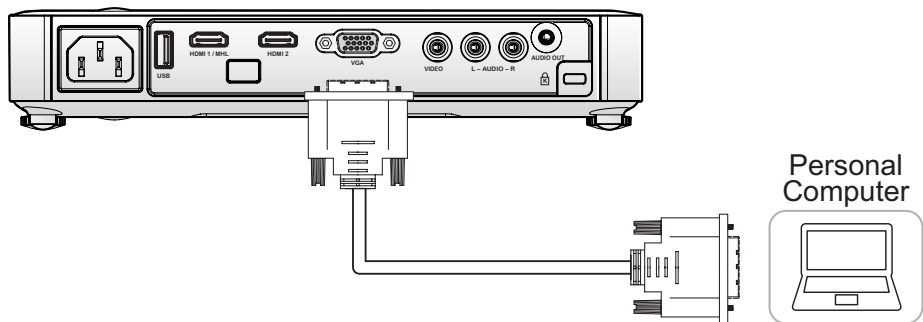

Note:

The personal computer must have a VGA output port to use the VGA cable to connect to the Qumi.



Inserting a USB Flash Disc

Connect a USB Flash Disc to the Qumi by inserting the storage device(s) into the appropriate port.

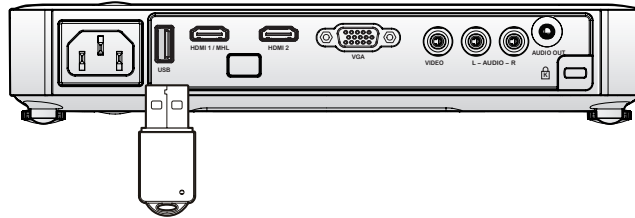

Connecting Video

Connect audio/video devices to the Qumi by using the audio/video cable.

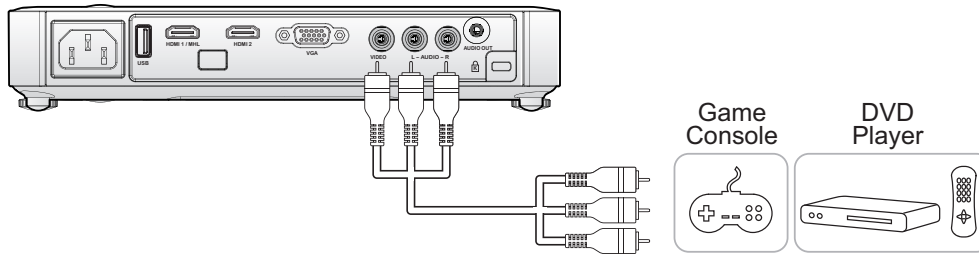

Connecting Audio

Connect earphones or mini speakers to the Qumi by inserting into the Audio Out port.

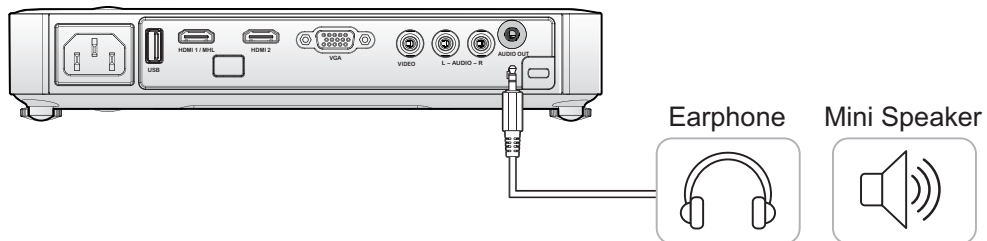

Starting and Shutting down the Qumi

1. Connect the AC power cord to the Qumi. Connect the other end of the AC power cord to a wall outlet.

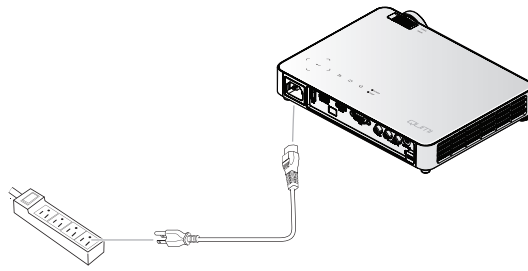

2. Press the  **POWER** button to turn on the Qumi.

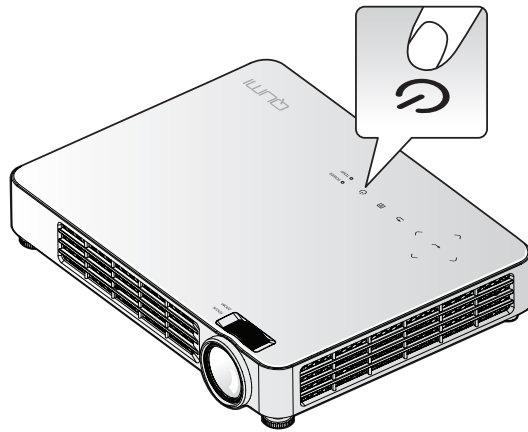

The Qumi splash screen displays and connected devices are detected.

See *Setting an Access Password (Security Lock)* on page 11 if security lock is enabled.



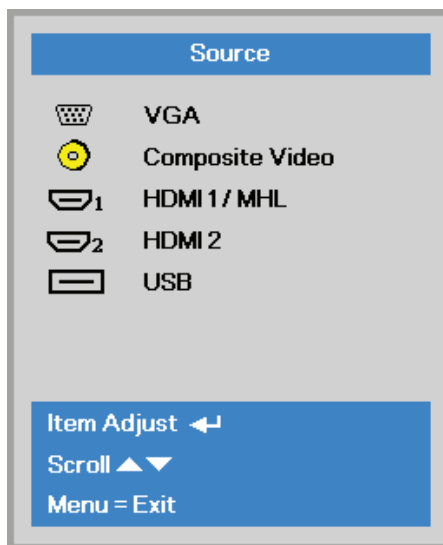

3. If more than one input device is connected, press the **SOURCE** button on the remote control and use the **▲** or **▼** buttons to select the applicable device or press **▲** and **▼** or **◀** and **▶** at the same time on the keypad on the Qumi.

- VGA: Analog RGB, Component: DVD input YCbCr / YPbPr, or HDTV input YPbPr
- Composite Video: Traditional composite video
- HDMI 1 / MHL: HDMI / DVI / MHL
- HDMI 2: HDMI / DVI
- USB: USB Flash Disc

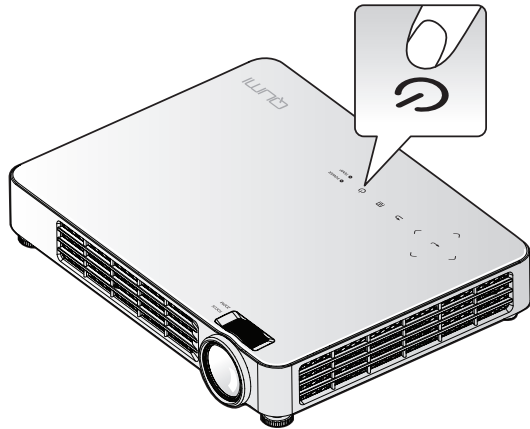

4. Press the  **POWER** button to turn off the Qumi.



5. When the “Power Off? /Press Power again” message appears, press the  **POWER** button. The projector turns off.

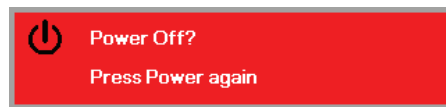

Adjusting the Image

Use the **Image-zoom** control (on the projector) to resize the projected image and screen size (B).

Use the **Image-focus** control (on the projector) to sharpen the projected image (A).

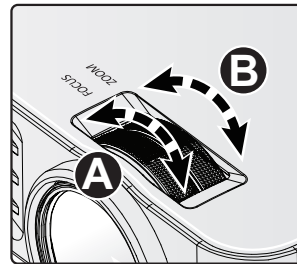

Setting an Access Password (Security Lock)

To prevent unauthorized use of the Qumi, you can create a password. When the access password function is enabled, the password must be entered after the Qumi has been turned on.

Creating a password can be done by performing the following steps:

1. Press the **MENU** button on the remote control or press **MENU** on the keypad to open the On-Screen Display (OSD) menu.

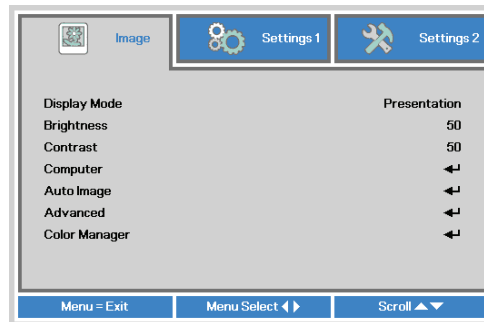

2. Move the cursor to the **Settings 1** tab and scroll down to select **Advanced 1**.

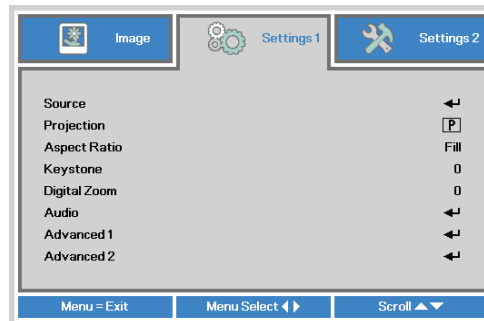

3. Press the **▲** or **▼** button to select **Security Lock** and press **←**.

4. Press the **◀** or **▶** button to enable or disable the security lock function.

A password dialog box automatically appears.

5. You can use the **▲▼◀▶** buttons located either on top of the Qumi or on the remote control to enter the password. Any combination of the navigation buttons can be used (five must be chosen).

Press the navigation buttons in any order to set the password.

Then press the **MENU** button to exit the dialog box.

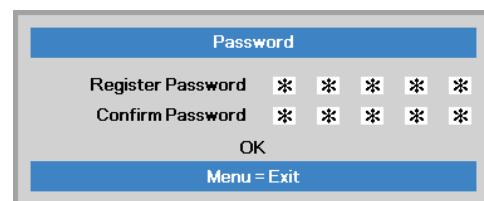
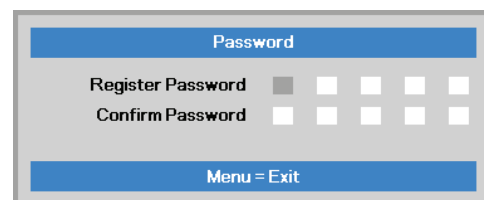

6. The password confirmation menu appears when you power on the Qumi when the **Security Lock** is enabled.

Enter the password that was created in step 5.

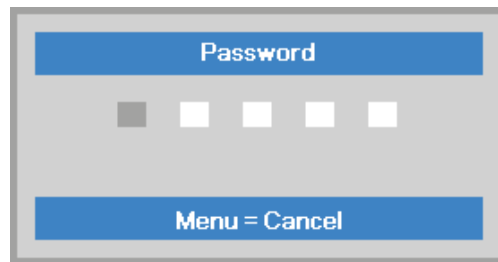

Important:

Keep the password in a safe place. Without the password, you will not be able to use the Qumi. If you lose the password, contact your reseller for information on resetting the password.

Using a Tripod

The Qumi can be used with a tripod by connecting the tripod to the bottom of the Qumi. Many typical tripods can be connected.

Supported Tripod Specifications:

- Type: Mini tripod
- Slot size: 1/4-20 L6.3 mm

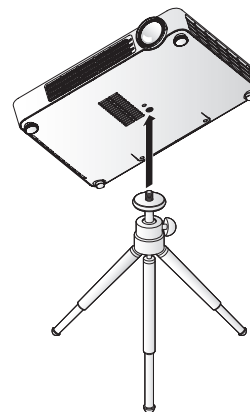

Adjusting Projector Level

Take note of the following when setting up the projector:

- The projector table or stand should be level and sturdy.
- Position the projector so that it is perpendicular to the screen.
- Ensure the cables are in a safe location. You could trip over them.

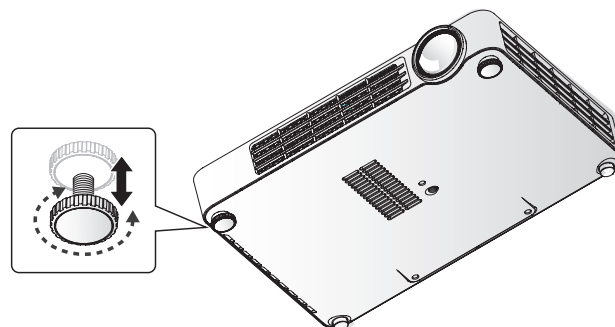

To adjust the angle of the picture, turn the tilt-adjuster right or left until the desired angle has been achieved.

Setting Up the Remote Control

The remote control comes with one (1) 3V lithium battery (CR2025). The battery is pre-installed in the remote control.

To begin using the remote control, remove the plastic tab (A) from the battery compartment.

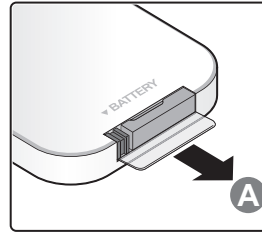

Replacing the Remote Control Batteries

- 1.** Remove the battery compartment cover by sliding the cover towards the arrow (A). Then pull out the cover towards the arrow (B).
- 2.** Remove the old battery and insert the new battery with the positive side facing up.
- 3.** Install the cover.

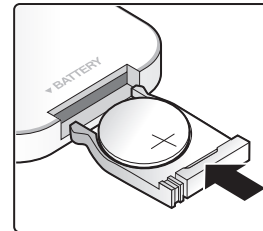
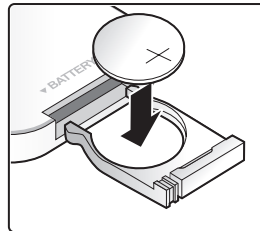
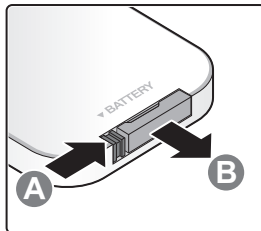

Caution:

- 1.** Use only a 3V lithium battery (CR2025).
- 2.** Dispose of used batteries according to local ordinance regulations.
- 3.** Remove the battery when not using the Qumi for prolonged periods.

Operating Range

The remote control uses infrared (IR) transmission to control the Qumi. It is not necessary to point the remote directly at the Qumi.

The remote control functions properly within a radius of approximately 7 meters (23 feet) and 15 degrees above or below the Qumi level (if the remote is not held perpendicular to the sides or rear of the Qumi).

If the Qumi is unresponsive to the remote control, move closer towards the Qumi.



Chapter 3 Qumi Media Suite

Overview

The Qumi Media Suite is designed to provide easy access to your files from an inserted USB Flash Disc. Music, movies, pictures and documents can be displayed.



The media suite menu contains 8 applications that can be accessed:

- Music – A music player that supports many types of audio files, ready to play music.
- Movie – An easy to use movie player that displays multiple movie formats.
- Photo – A photo viewer that contains slide show functionality.
- Office viewer – A document viewer that displays documents.
- Wifi Display – Use this to configure the connection to a wireless access point.
- Web browser – A Web browser for surfing the Internet.
- Wifi – Use this to choose a Wi-Fi access point.
- Settings – The settings of the Qumi can be adjusted in this menu.

Note:

1. Wifi & Web browser functions are only available with Q7's dongle.

2. Plug a USB hub into Qumi's USB socket, then plug the Q7 Wi-Fi dongle, keyboard and mouse into the USB hub to surf the Internet easily.

Music



Supported Formats:

The music player can play music files in the following formats:

- MP3 (up to 256Kbps bit-rate)
- WMA, MID, MIDI, MP1, MP2, OGG, AAC, AMR, WAV, AC3, M4A, AWB, APE

Playing your Track

To open the music list, perform the following:

1. Press the ◀ or ▶ button to select the Music icon in the media suite menu.
2. Press ↵ to open the file directory.
3. Select the folder containing the desired song.
4. Press ↵ to play the desired song.

A song can be paused or can be played by selecting the Pause/Play button in the music player interface.



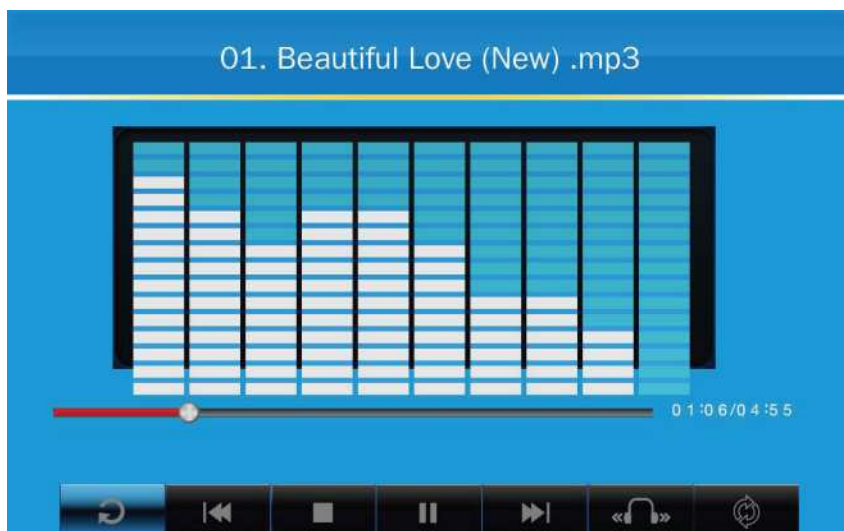

When the cursor is selecting the progress bar, a song can be paused or can be played by pressing ↵.

Control Interface



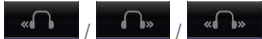

The music player interface contains the following controls:



The music player provides controls to navigate through a song playlist. The following table provides a description the controls.

| ACTION | DESCRIPTION |
|---|--|
|  | Toggle speaker output to Left/Right/Stereo |
|  | Return to previous/Forward to next track |
|  | Pause/Play track |
|  | Stop playback |
|  | Return to the previous menu |

The order of songs and playback mode can be adjusted. The following table provides a description of the playback modes.

| ACTION | DESCRIPTION |
|---|--|
|  | Songs in the playlist will play in a continuous order |
|  | All songs in the playlist will repeat |
|  | Only the current song playing will repeat |
|  | All songs in the playlist will be shuffled during playback |



Movies



Supported Formats

The following video formats are supported:

- H.264 video up to 720p at 30 frames per second; Main Profile level 3.1 with AAC-LC audio up to 160 Kbps, 48kHz, stereo audio in .m4v, .mp4, and .mov file formats
- MPEG-4 video up to 2.5 Mbps, 640 by 480 pixels at 30 frames per second; Simple Profile with AAC-LC audio up to 160 Kbps per channel, 48kHz, stereo audio in .m4v, .mp4, and .mov file formats
- Motion JPEG (M-JPEG) up to 35 Mbps, 1280 by 720 pixels, 30 frames per second, audio in U-Law, PCM stereo audio in .avi files
- Unicode subtitle file: .ssa, .ass, .srt, .smi

Watching Your Movie

To open a list of movies, perform the following:

1. Press the ◀ or ▶ button to select the Movie icon in the media suite menu.
2. Press ↵ to open the file directory.
3. Select the folder containing the desired movie file.
4. Press ↵ to play the desired movie file.

While a movie is playing, the control interface can be hidden. To hide the control interface, press the ▲ button or ⏻. Press the ▲ button or ⏻ again to show the control interface.

The control interface will automatically disappear if there is no user input for 5 seconds.



Control Interface

The following playback functions are controlled by the remote control, which are shown in the table below:

| ACTION | DESCRIPTION |
|--------|--|
| | Return to the previous menu |
| | Pause/Play track |
| | Show or hidden subtitle (if have) |
| | Return to previous/Forward to next track |
| | Full screen display or Actual Movie Size display |



Photos



Supported Formats

The photo viewer can open the following types of image files:

- BMP (up to 4000 x 3000 pixels)
- PNG (up to 4000 x 3000 pixels)
- JPG (up to 4000 x 3000 pixels)

Viewing Your Photo

When a USB Flash Disc is inserted, the Flash Disc folder icon will display in the file directory.

To open a photo in photo viewer, perform the following:

1. Press the ◀ or ▶ button to select the Photo icon in the media suite menu.
2. Press ⬅ to open the file directory.
3. Select the folder containing the desired photo.
4. Press ⬅ to display the desired photo.

To view the details of the photos, navigate to a photo. The details of the photo will appear on the bottom of the screen.

To view photos in full screen mode, perform the following:

1. Navigate to a photo.
2. Press ⬅ to view the photo in full screen mode.





To utilize the Zoom-In tool, press ⬅. (2X, 4X, 8X, 16X).

In order to zoom out to the default size of the image, press the Exit key.

While a photo is displayed, the control interface can be hidden. To hide the control interface, press the ▲ button or ⏏. Press the ▲ button or ⏏ again to show the control interface.

Control Interface

The photo viewer contains the following controls:

| ACTION | DESCRIPTION |
|---|---|
|  | Return to the previous menu. |
|  | Sets the Slide Show interval. |
|  | View photos in Slide Show mode. |
|  | Rotate the photo in a counter-clockwise position. |
|  | Rotate the photo in a clockwise position. |



Office Viewer



Supported Formats

The document viewer in the Qumi Media Suite can open the following types of documents:

- Microsoft® Word (97-2007, .doc/.docx)
- Microsoft® PowerPoint (97-2007, .ppt/.pptx) (not support Animation and slide transitions)
- Microsoft® Excel (97-2007, .xls/.xlsx)
- Adobe® PDF (.pdf) (PDF 1.0, 1.1, 1.2, 1.3 and 1.4)
- Text (.txt)

Selecting Your Document

To open a file in document viewer, perform the following:

1. Press the ◀ or ▶ button to select the Office Viewer icon in the media suite menu.
2. Press ◀ to open the file directory.
3. Select the folder containing the desired file.
4. Press ◀ to display the desired file.

Once a file is open, press ◀ to zoom in for a larger view of the file. Files can be zoomed in 2X, 4X, 8X and 16X views. Use the navigation keys to move the view of the file.

To proceed to the next page or return to a previous page, press the ▲ or ▼ button.

Note:

You cannot move to the previous or next page if the view is zoomed in.

Control Interface

The office viewer does not contain a dedicated control interface.



Wifi



Turning on WiFi

Insert the Q7 WiFi dongle in the Qumi to surf the Web through a web browser.

To turn on WiFi, perform the following:

1. Press the ◀ or ▶ button to select the Wifi icon in the media suite menu.
2. Press ⬅ to enter Network Settings.

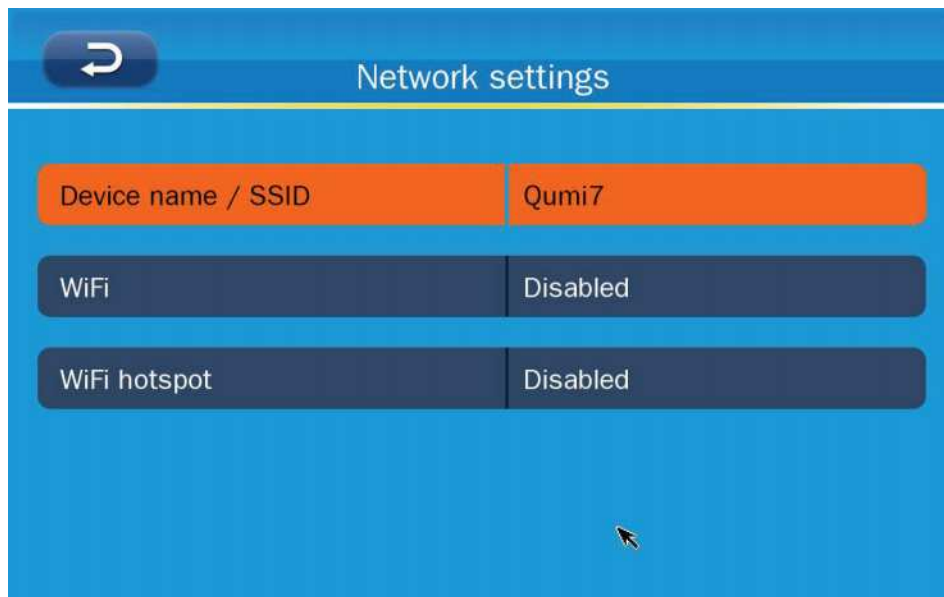

- Device Name / SSID: Enter the Service Set Identifier here.
- WiFi: Enable WiFi function and connecting to an exist WiFi AP.
- WiFi hotspot: Let Q7 to be an AP and allowed PC to do WiFi display.

3. Press the ◀ or ▶ button to select Enable and then press ⬅ to turn on WiFi function.
4. Press the ▲ or ▼ button to select an AP and then press ⬅ to connect.



Note:

1. The Wifi function is only available with Q7's dongle.
2. WiFi and WiFi hotspot can not work at the same time.
3. Press **Page Up** on the remote control to return to the top of the function area. From here, you can refresh the AP list.
4. Press **Page Down** to move to the bottom of the AP list when in the function area.

WiFi Control Interface

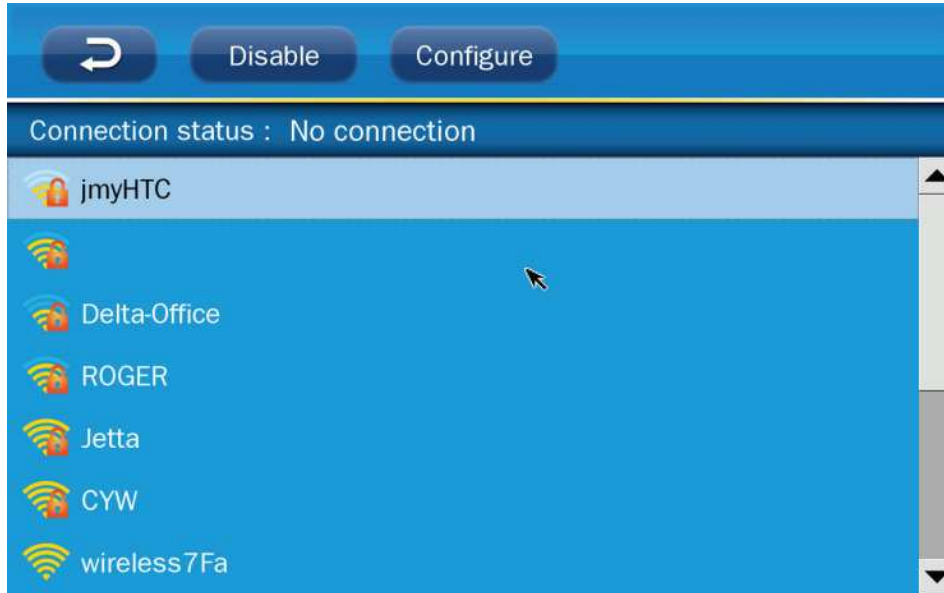
The WiFi Setting contains the following controls:



| ACTION | DESCRIPTION |
|---|------------------------|
|  | Return to Main Window. |
|  | Enable/Disable WiFi. |
|  | WiFi configuration. |



WiFi Configure

The WiFi Configure setting lets you setup a dynamic (Default) or static IP connection.

| ACTION | DESCRIPTION |
|------------|---|
| IP Address | Configure the IP address of the projector here. |
| Netmask | Configure the subnet mask here. |
| Gateway | Configure the IP address of the default gateway here. |
| DNS | Configure the IP address of the DNS server here. |

WiFi hotspot control interface

The WiFi hotspot interface lets you enable or disable the use of a hotspot through the Qumi. Select Use default IP or Use other IP, then click **Apply** to configure the WiFi hotspot interface.

Web browser







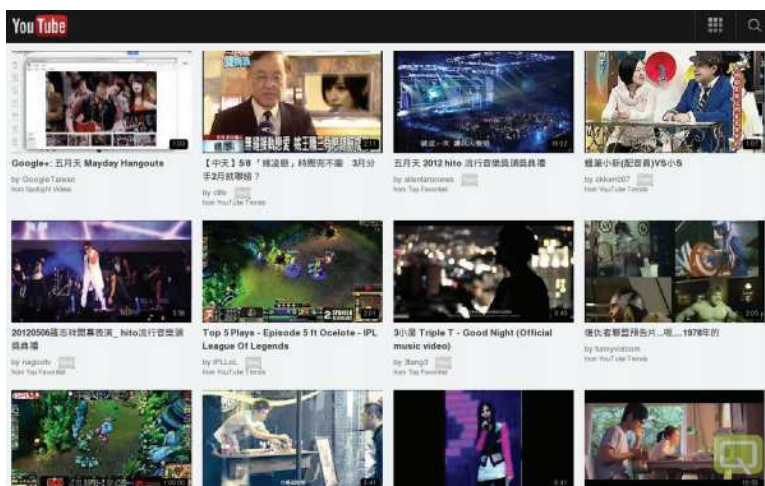



Visiting a website

1. Plug the Q7 Wi-Fi Dongle into Qumi's USB socket.
2. Press ▲ ▼ ◀ ▶ on the remote control to control the cursor. See *Remote Control* on page 4.
3. Use the remote control for navigation control. Press the Q icon (bottom-right) to access the address bar.
4. Press ⬅ to display the virtual keyboard, or press  in the address bar.



Control Interface

The Main bar contains the following controls:

| ACTION | DESCRIPTION |
|---|--|
|  | Go back one page. |
|  | Go to next page. |
|  | Reload current page/Stop loading current page. |
|  | Back to Home page. |
|  | Enter bookmark page. |
|  | Add/Delete current page to bookmark |
| <input data-bbox="263 1825 470 1848" type="text" value="http://m.youtube.com/#home"/> | Click to enter URL input page. |
|  | Zoom in/out page. |
|  | Clear History and Exit browser. |

Wifi Display



Set Wifi Display

1. Plug the Q7 Wi-Fi Dongle into Qumi's USB socket.
2. Set Network settings > Wifi to Enabled or Wifi hotspot to Enabled.
3. Press the ◀ or ▶ button to select the Wifi Display icon in the media suite menu.



Settings



System Options

The system options menu displays the system and firmware information. The Information menu provides details about the software version.

Play Mode

The play mode menu displays settings for both video and music player options. The following settings are available:

- Repeat None – The videos or music tracks will not repeat after it is completed.
- Shuffle – The order of videos or music tracks will play in a random order.
- Repeat One – A selected video or music track will continuously repeat after it is completed.
- Repeat All – All videos or music tracks in a playlist will repeat after all of the files in the playlist have been completed.

Note:

The Qumi media suite always supplies an output of 1280x800 resolution to the system, so the OSD displays a resolution of 1280x800 as its received signal. This does not indicate the actual resolution of the actual multimedia files.

USB Options

The USB Mass Storage option allows you to connect a personal computer with a USB cable to transfer files between the Qumi and personal computer.

Note:

The Qumi media suite only supports input from USB Flash Disc.

System Upgrade

The System Upgrade option allows you to perform firmware upgrades through a USB Flash Disc.

Copy the latest firmware onto the USB Flash Disc and insert into the Qumi.



AutoPlay Option

Use the AutoPlay Option menu to configure what the Qumi automatically plays when powered on. The following settings are available when AutoPlay is ON.

- AutoPlay – Turn on or off auto play.
- AutoPlay Type – Automatically play photo or video files when powered on.
- File Path – Automatically play files in the root of USB or local memory.

To use AutoPlay on Qumi:

1. Connect PC to Qumi using a USB cable.
2. Move media files to respective folder (Movies for movie files or Photos for image files).

To use AutoPlay on USB Flash Disc:

1. Create Movies or Photos folder in USB Flash Disc.
2. Copy media files to respective folder (Movies for movie files or Photos for image files).
3. Remove USB Flash Disc and insert in Qumi.

Note:

1. *AutoPlay files on USB Flash Disc must be named Movies or Photos for this function to play media files.*
2. *Built-in memory for Qumi Q7 is 4GB.*



Chapter 4 On-Screen Display (OSD) Settings

OSD Menu Controls

The Qumi has an On-Screen Display (OSD) settings menu that allows you to make adjustments and changes to settings, such as display settings and audio settings. There are 3 menus within the OSD menu:

- Image – Various aspects of the image quality can be adjusted in this menu.
- Setting 1 – Default language and other settings can be adjusted in this menu.
- Setting 2 – Auto source and other settings can be adjusted in this menu.

If the interface is set on AV-IN, HDMI/MHL or VGA, the OSD menu can be accessed by pressing the MENU button on the remote control or keypad.

If the interface is set on the Qumi Media Suite menu, the OSD menu can be accessed by pressing the **MENU** button on the remote control or pressing **MENU** on the keypad.

Note:

If the OSD menu is inactive for 15 seconds, the OSD menu will close.

Navigating the OSD

The remote control cursor buttons or the buttons on the top of the Qumi can be used to navigate and make changes to the OSD settings.

1. Enter the **OSD** menu.
2. Press the ◀ or ▶ button to move through the 3 menus.
3. Press the ▲ or ▼ button to move the cursor up and down within in a menu and press ←.
4. Press ◀ or ▶ to change the values for specific settings.
5. Press **MENU** button or **EXIT** on the remote control to close the OSD or close a submenu.

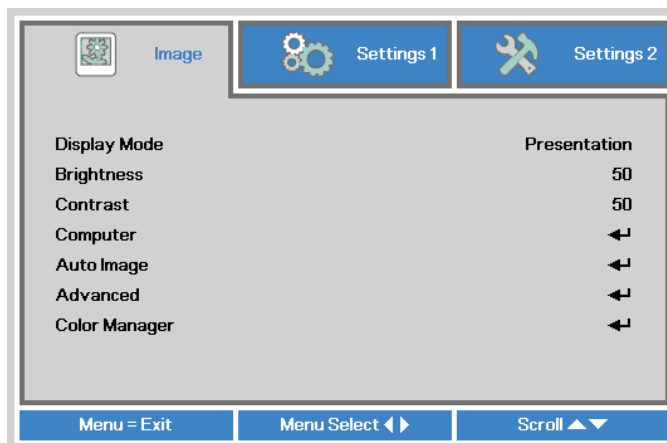

Note:

Depending on the video source, not all items in the OSD can be modified. For example, the Horizontal/Vertical Position items in the Image > Computer menu can only be modified when the Qumi is connected to a PC through a VGA cable. Settings that are not enabled or that cannot be modified are gray in color.



Setting the OSD Language

The language that is displayed in the OSD can be changed. To change the language in the OSD, perform the following steps:

1. Enter the **OSD** menu. Press the ◀ or ▶ button to select the **Setting 1** and press ↵.
2. Press the ▲ or ▼ button to move to the **Advanced 1** menu.

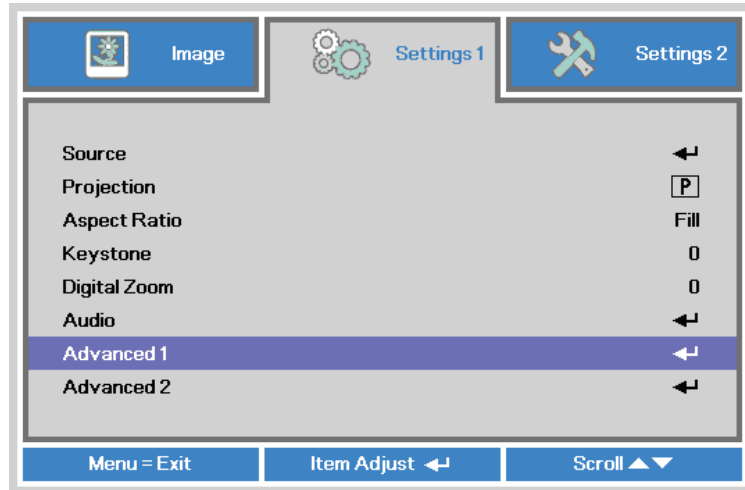

3. Press ↵ to enter the **Advanced 1** sub menu.
4. Press the ▲ or ▼ button until the cursor highlights the **Language** setting and press ↵.

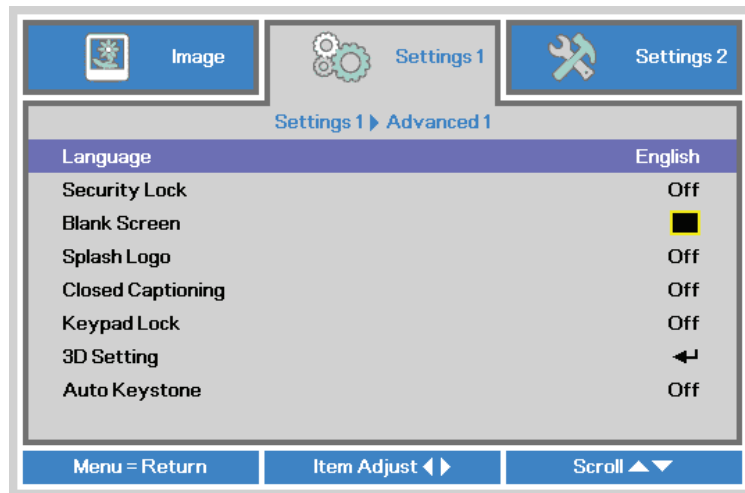

5. Press the cursor button until the language you want is highlighted.
6. Press the **EXIT** button or **MENU** button four to close the OSD.



OSD Menu Overview

Use the following illustration to quickly find a setting or determine the range for a setting.

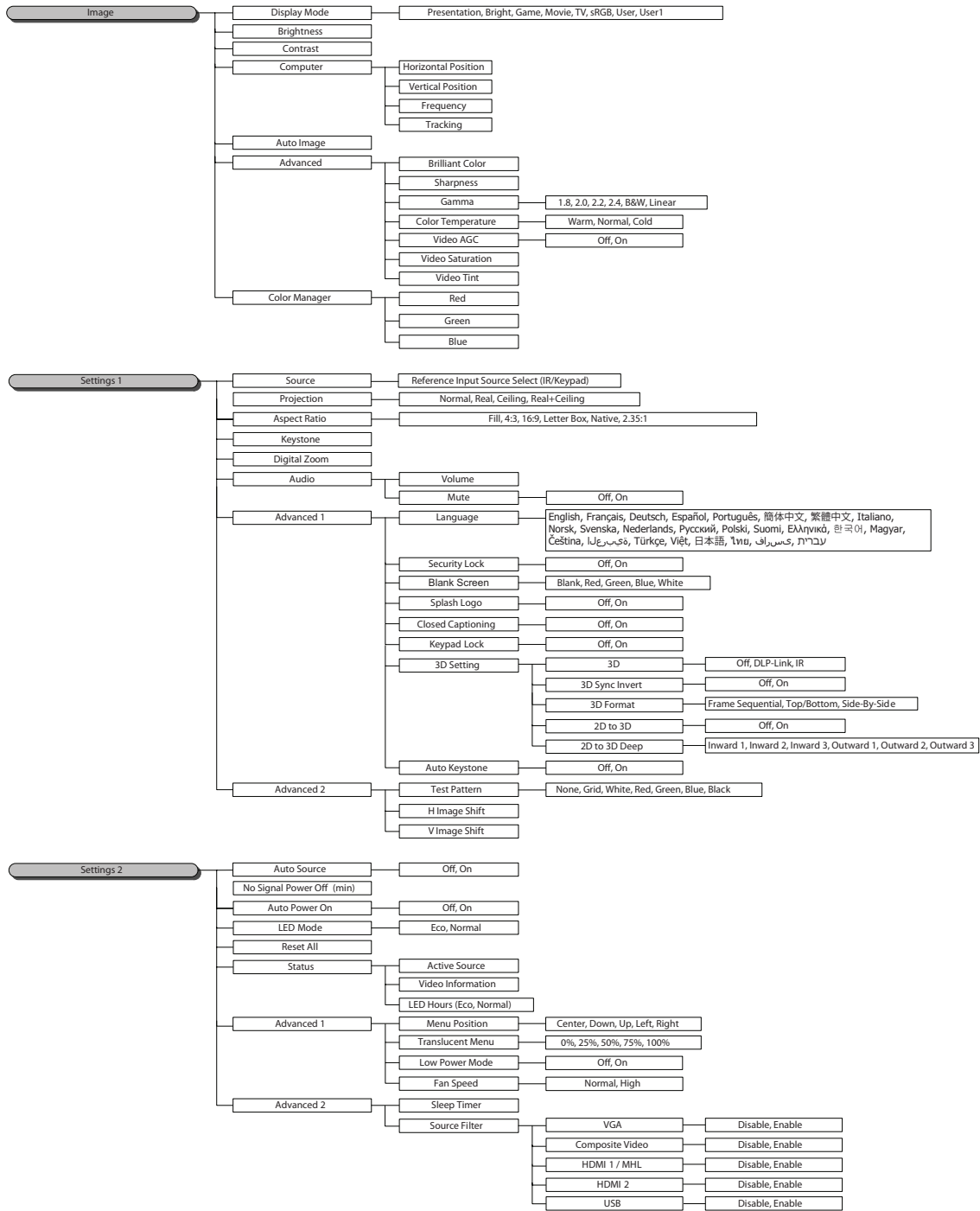
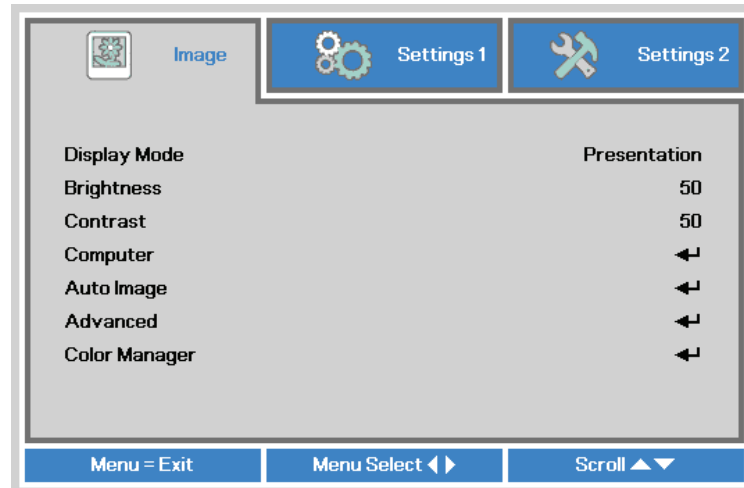

Image Menu

To access the **Image** menu and adjust the settings, perform the following steps:

1. Enter the **OSD** menu.
2. Press the ◀ or ▶ button to select the **Image** menu.
3. Press the ▲ or ▼ button to move the cursor up or down in the **Image** menu and press ↵.
4. Press the ◀ or ▶ button to change values for each applicable setting.



| ITEM | DESCRIPTION |
|---------------|---|
| Display Mode | Press the ◀ or ▶ button to set the display mode. |
| Brightness | Press the ◀ or ▶ button to adjust the display brightness. |
| Contrast | Press the ◀ or ▶ button to adjust the display contrast. |
| Computer | Press ↵ to enter the Computer menu. See <i>Computer</i> on page 31. |
| Auto Image | Press ↵ to enter automatically adjustment for phase, tracking, size and position. |
| Advanced | Press ↵ to enter the Advanced menu. See <i>Advanced</i> on page 32. |
| Color Manager | Press ↵ to enter the Color Manager menu. See <i>Color Manager</i> on page 33. |

Note:

Color Manager is adjustable only when the Display Mode is set to User1.



Computer

To access the **Computer** menu and adjust the settings, perform the following steps:

1. Enter the **OSD** menu.
2. Press the ◀ or ▶ button to select the **Image** menu.
3. Press the ▲ or ▼ button to move to the **Computer** menu and press ◀.
4. Press the ◀ or ▶ button to change values for each applicable setting.

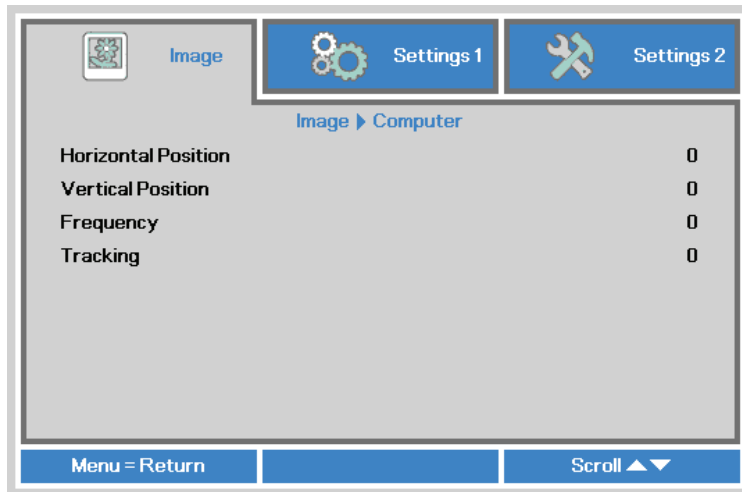

| ITEM | DESCRIPTION |
|---------------------|--|
| Horizontal Position | Press the ◀ or ▶ button to adjust the display position to left or right. |
| Vertical Position | Press the ◀ or ▶ button to adjust the display position to up or down. |
| Frequency | Press the ◀ or ▶ button to adjust the A/D sampling clock. |
| Tracking | Press the ◀ or ▶ button to adjust the A/D sampling dot. |

Note:

Items in the **Computer** menu can only be modified when the Qumi is connected to a PC through a VGA cable. Settings that are not enabled or that cannot be modified are gray in color.



Advanced

To access the **Advanced** menu and adjust the settings, perform the following steps:

1. Enter the **OSD** menu.
2. Press the ◀ or ▶ button to select the **Image** menu.
3. Press the ▲ or ▼ button to move to the **Advanced** menu and press ◀.
4. Press the ▲ or ▼ button to move the cursor up or down in the **Advanced** menu.

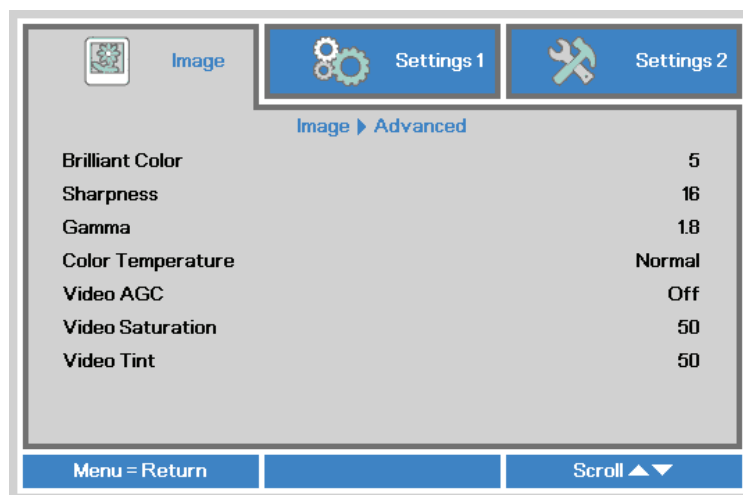

| ITEM | DESCRIPTION |
|-------------------|---|
| Brilliant Color | Press the ◀ or ▶ button to adjust the brilliant color value. |
| Sharpness | Press the ◀ or ▶ button to adjust the display sharpness level. |
| Gamma | Press the ◀ or ▶ button to adjust the gamma correction of the display. |
| Color Temperature | Press the ◀ or ▶ button to adjust the color temperature. |
| Video AGC | Press the ◀ or ▶ button to enable or disable the Automatic Gain Control for video source. |
| Video Saturation | Press the ◀ or ▶ button to adjust the video saturation. |
| Video Tint | Press the ◀ or ▶ button to adjust the video tint/hue. |

Note:

Video AGC, Video Saturation, Video Tint and Closed Caption settings are adjustable only when the source is from composite video.

Color Manager

To access the **Color Manager** menu and adjust the settings, perform the following:

1. Enter the **OSD** menu.
2. Press the ◀ or ▶ button to select the **Image** menu.
3. Press the ▲ or ▼ button to move the cursor up or down in the **Color Manager** menu and press ↵.
4. Press the ◀ or ▶ button to change values for each applicable setting.

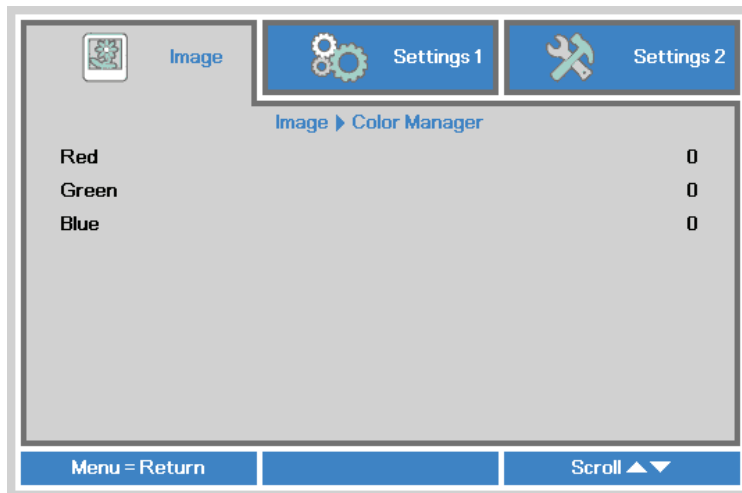

| ITEM | DESCRIPTION |
|-------|--|
| Red | Press the ◀ or ▶ button to adjust the LED Red PWM. |
| Green | Press the ◀ or ▶ button to adjust the LED Green PWM. |
| Blue | Press the ◀ or ▶ button to adjust the LED Blue PWM. |



Settings 1 Menu

To access the **Settings 1** menu and adjust the settings, perform the following steps:

1. Enter the **OSD** menu.
2. Press the ◀ or ▶ button to select the **Settings 1** menu.
3. Press the ▲ or ▼ button to move the cursor up and down in the **Settings 1** menu and press ↵.
4. Press the ◀ or ▶ button to change values for each applicable setting.

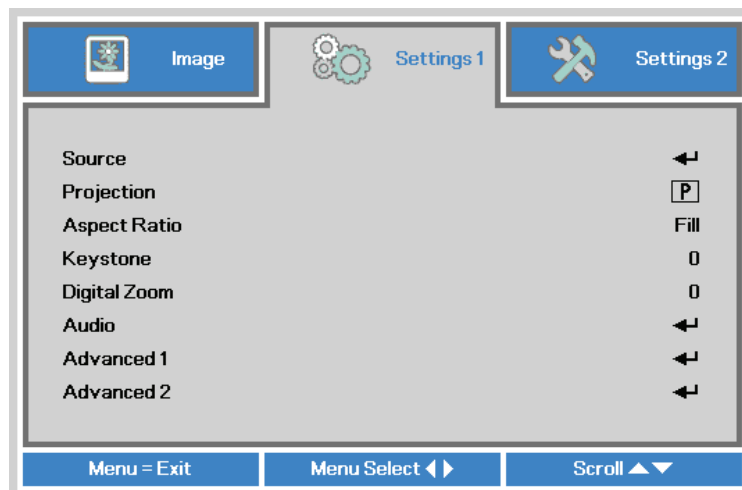

| ITEM | DESCRIPTION |
|--------------|---|
| Source | Press ↵ to enter the Source menu. |
| Projection | Press the ◀ or ▶ button to choose from four projection methods: Front, Rear, Ceiling-Front, Ceiling-Rear. |
| Aspect Ratio | Press the ◀ or ▶ button to adjust the video aspect ratio. |
| Keystone | Press the ◀ or ▶ button to adjust the display keystone. |
| Digital Zoom | Press the ◀ or ▶ button to adjust the digital zoom in or zoom out. |
| Audio | Press ↵ to enter the Audio menu. See <i>Audio</i> on page 35. |
| Advanced 1 | Press ↵ to enter the Advanced 1 menu. See <i>Advanced 1</i> on page 36. |
| Advanced 2 | Press ↵ to enter the Advanced 2 menu. See <i>Advanced 2</i> on page 38. |

Audio

To adjust the audio settings, press **←** to enter the **Audio** sub menu.



| ITEM | DESCRIPTION |
|--------|--|
| Volume | Press the ◀ or ▶ button to adjust the audio volume. |
| Mute | Press the ◀ or ▶ button to turn on or off the speaker. |



Advanced 1

To adjust the advanced settings, press **←** to enter the **Advanced 1** sub menu.

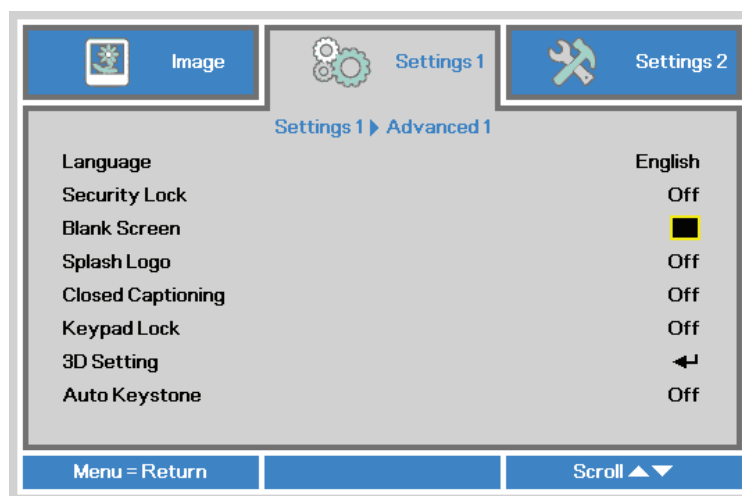

| ITEM | DESCRIPTION |
|-------------------|--|
| Language | Press the ◀ or ▶ button to select a different localization menu. |
| Security Lock | Press the ◀ or ▶ button to enable or disable security lock function. |
| Blank Screen | Press the ◀ or ▶ button to select different color to blank the screen. |
| Splash Logo | Press the ◀ or ▶ button to show logo or not. |
| Colsed Captioning | Press the ◀ or ▶ button to enable or disable colsed captioning. |
| Keypad Lock | Press the ◀ or ▶ button to enable or disable keypad lock function. |
| 3D Setting | Press ← to enter the 3D menu. See <i>3D Setting</i> on page 37. |
| Auto Keystone | Press the ◀ or ▶ button to enable or disable automatic keystone. |

Note:

To use the 3D function, the Play Movie in 3D setting found in your player under the 3D Disc Menu must be enabled. 3D functionality works when the input source supports 120Hz.

1. The 3D OSD menu item is gray if there is no appropriate 3D source. This is the default setting.
2. When the projector is connected to an appropriate 3D source, the 3D OSD menu item is enabled for selection.
3. Use 3D glasses to view a 3D image.
4. You need 3D content from a 3D DVD or 3D media file.
5. You need to enable the 3D source (some 3D DVD content may have a 3D on-off selection feature).
6. You need DLP link 3D or IR 3D shutter glasses. With IR 3D shutter glasses, you need to install a driver on your PC and connect a USB emitter.
7. The 3D mode of the OSD needs to match the type of glasses (DLP link or IR 3D).
8. Power on the glasses. Glasses normally have a power on-off switch. Each type of glasses has their own configuration instructions. Please follow the configuration instructions that come with your glasses to finish the setup process.

3D Setting

To adjust the 3D settings, press **←** to enter the **3D Setting** sub menu.

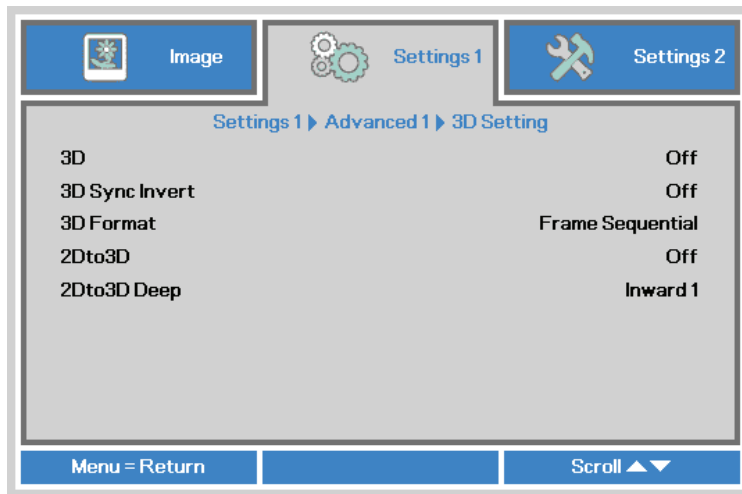

| ITEM | DESCRIPTION |
|----------------|---|
| 3D | Press the ◀ or ▶ button to select Off, DLP-Link or IR. |
| 3D Sync Invert | Press the ◀ or ▶ button to turn 3D sync Invert on or off. |
| 3D Format | Press the ◀ or ▶ button to select Frame Sequential, Top / Bottom, Side by Side. |
| 2Dto3D | Press the ◀ or ▶ button to enable or disable 2Dto3D function. |
| 2Dto3D Deep | Press the ◀ or ▶ button to select different 2Dto3D deep. |



Advanced 2

To adjust the advanced settings, press **←** to enter the **Advanced 2** sub menu.

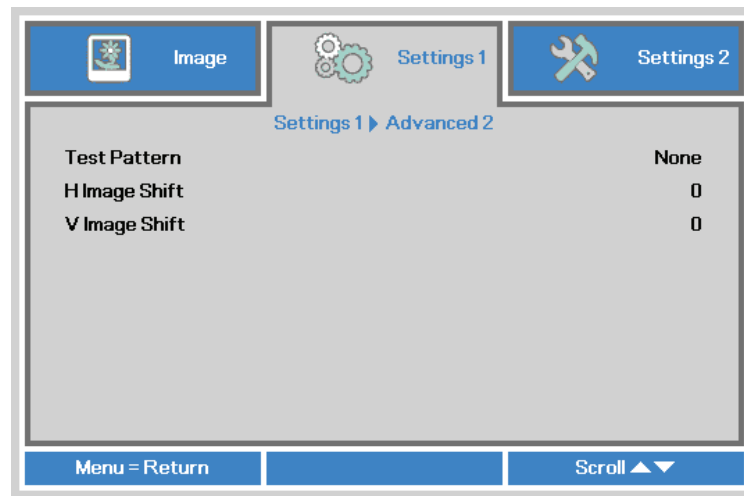

| ITEM | DESCRIPTION |
|---------------|---|
| Test Pattern | Press the ◀ or ▶ button to select different test pattern. |
| H Image Shift | Press the ◀ or ▶ button to shift the horizontal position. |
| V Image Shift | Press the ◀ or ▶ button to shift the vertical position. |



Settings 2 Menu

To access the **Settings 2** menu and adjust the settings, perform the following steps:

1. Enter the **OSD** menu.
2. Press the ◀ or ▶ button to select the **Settings 2** menu.
3. Press the ▲ or ▼ button to move the cursor up and down in the **Settings 2** menu and press ↵.
4. Press the ◀ or ▶ button to change values for each applicable setting.

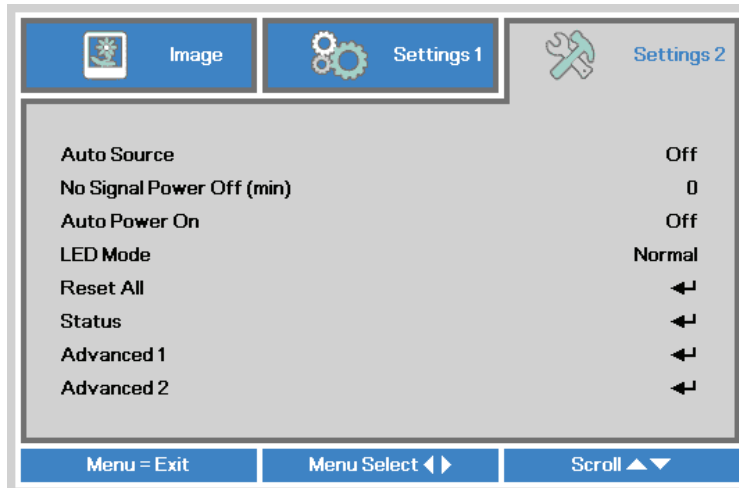

| ITEM | DESCRIPTION |
|---------------------------|--|
| Auto Source | Press the ◀ or ▶ button to enable or disable automatic source detection. |
| No Signal Power Off (min) | Press the ◀ or ▶ button to automatically turn the projector lamp off when there is no signal. |
| Auto Power On | Press the ◀ or ▶ button to enable or disable automatic power on. |
| LED Mode | Press the ◀ or ▶ button to select the LED mode for higher brightness or lower brightness to save LED life. |
| Reset All | Press ↵ to reset all items to factory preset values. See <i>Reset All</i> on page 40. |
| Status | Press ↵ to enter the Status menu. See <i>Status</i> on page 41. |
| Advanced 1 | Press ↵ to enter the Advanced 1 menu. See <i>Advanced 1</i> on page 42. |
| Advanced 2 | Press ↵ to enter the Advanced 2 menu. See <i>Advanced 2</i> on page 43. |

Reset All

To reset all of the menu items to the factory default values (except Language and Security Lock), perform the following steps:

1. Enter the **OSD** menu.
2. Press the ◀ or ▶ button to select the **Settings 2** menu.
3. Press the ▲ or ▼ button to select the **Reset All** menu and press ←.

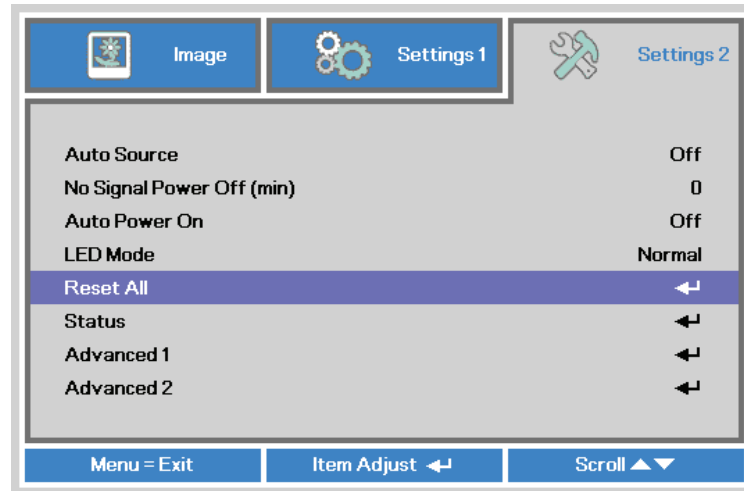

Status

To see the status of the Qumi, perform the following steps:

1. Enter the **OSD** menu.
2. Press the ◀ or ▶ button to select the **Settings 2** menu.
3. Press the ▲ or ▼ button to select the **Status** menu and press ↵.

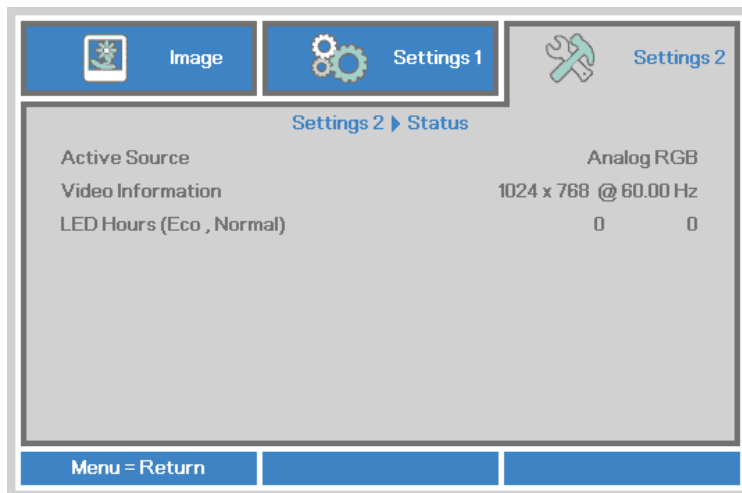

| ITEM | DESCRIPTION |
|-------------------|---|
| Active Source | Displays the activated source. |
| Video Information | Displays resolution/video information for RGB source and color standard for Video source. |
| LED Hours | LED use information is displayed (in hours). Eco and Normal counters are separated. |

Advanced 1

To access the **Advanced 1** menu and adjust the settings, perform the following steps:

1. Enter the **OSD** menu.
2. Press the ◀ or ▶ button to select the **Settings 2** menu.
3. Press the ▲ or ▼ button to select the **Advanced 1** menu and press ◀.
4. Press the ▲ or ▼ button to move the cursor up or down in the **Advanced 1** menu.
5. Press the ◀ or ▶ button to change values for each applicable setting.

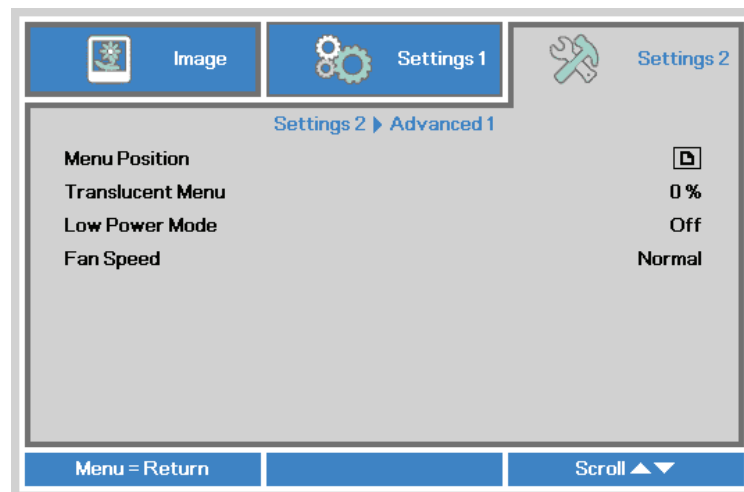

| ITEM | DESCRIPTION |
|------------------|--|
| Menu Position | Press the ◀ or ▶ button to select different OSD location. |
| Translucent Menu | Press the ◀ or ▶ button to select OSD background translucent level. |
| Low Power Mode | Press the ◀ or ▶ button to enable (<0.5W power consumption) or disable low power mode. Note: <i>Enable Low Power Mode to completely power down when the projector is turned off. Disable Low Power Mode to allow multimedia functionality when the projector is turned off.</i> |
| Fan Speed | Press the ◀ or ▶ button to enter and toggle between Normal and High fan speeds. Note: <i>We recommend selecting high speed in high temperature, high humidity, or high altitude (higher than 1500m/4921ft) areas.</i> |

Advanced 2

To access the **Advanced 2** menu and adjust the settings, perform the following steps:

1. Enter the **OSD** menu.
2. Press the ◀ or ▶ button to select the **Settings 2** menu.
3. Press the ▲ or ▼ button to select the **Advanced 2** menu and press ◀ or ▶.
4. Press the ▲ or ▼ button to move the cursor up or down in the **Advanced 2** menu.
5. Press the ◀ or ▶ button to change values for each applicable setting.

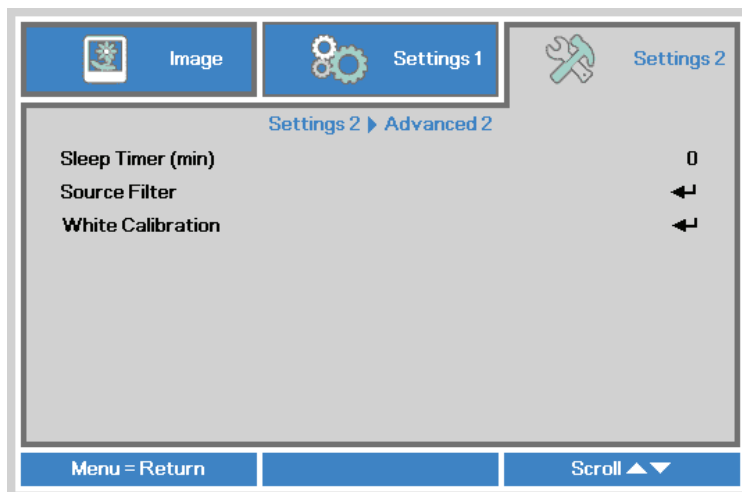

| ITEM | DESCRIPTION |
|-------------------|---|
| Sleep Timer | Press the ◀ or ▶ button to adjust the time for automatically lamp off (in minutes). |
| Source Filter | Press ◀ or ▶ to enter the Source Filter menu. See <i>Source Filter</i> on page 44. |
| White Calibration | Press ◀ or ▶ to activate the white calibration for re-build LED sensor data. |



Source Filter

To adjust the source filter, press ◀ or ▶ to enter the **Source Filter** sub menu.

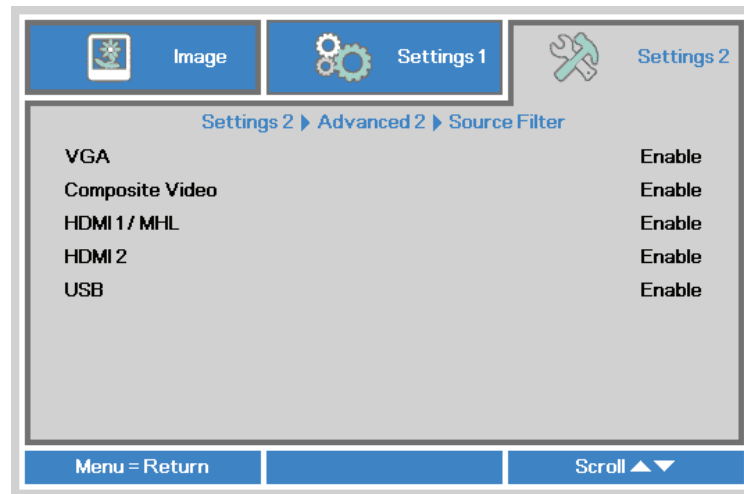

| ITEM | DESCRIPTION |
|-----------------|--|
| VGA | Press the ◀ or ▶ button to enable or disable VGA source in auto search loop. |
| Composite Video | Press the ◀ or ▶ button to enable or disable Composite Video source in auto search loop. |
| HDMI 1 / MHL | Press the ◀ or ▶ button to enable or disable HDMI 1 / MHL source in auto search loop. |
| HDMI 2 | Press the ◀ or ▶ button to enable or disable HDMI 2 source in auto search loop. |
| USB | Press the ◀ or ▶ button to enable or disable USB source in auto search loop. |



Chapter 5 Taking Care of Your Qumi

Cleaning the Qumi

Cleaning the Qumi to remove dust and grime will help provide trouble-free operation.

Warning:

1. *The Qumi should be turned off and unplugged before cleaning. Failure to do so may result in injury or damage to the system.*
2. *Use only a dampened cloth when cleaning. Do not allow water to enter the ventilation openings on the Qumi.*
3. *If a small amount of water gets into the interior of the Qumi while cleaning, unplug the Qumi and set in a well ventilated area for several hours before using.*
4. *If a large amount of water gets into the interior of the Qumi when cleaning, unplug the Qumi and have it serviced.*

Cleaning the Lens

Optical lens cleaning solutions can be purchased from most camera and other retail stores. To clean the Qumi lens, perform the following steps:

1. Apply a small amount of the optic lens cleaning solution to a clean and soft cloth. (Do not apply the cleaning solution directly to the lens.)
2. Gently wipe the lens in a circular motion.

Caution:

1. *Do not use abrasive cleaners or solvents.*
2. *To prevent discoloration or fading, do not allow the cleaning solution to contact the Qumi case.*

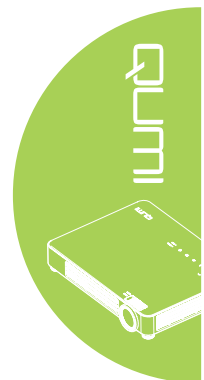

Troubleshooting

Common Problems and Solutions

These guidelines provide tips to deal with problems you may encounter while using the Qumi. If the problem remains unresolved, contact your dealer for assistance.

The problem sometimes can be as simple as a wire that is not completely connected. Review the following possible issues before proceeding to the problem-specific solutions.

- Use another electrical device to confirm that the electrical outlet is properly working.
- Make sure that the Qumi is turned on.
- Make sure all connections are securely connected.
- Make sure that the connected device is turned on.
- Make sure that the connected PC is not in suspend or sleep mode.
- Make sure the connected notebook computer is properly configured for an external display.

Tips for Troubleshooting

In each problem-specific section, perform the steps in the order suggested. Doing so may help solve the problem more quickly.

In order to avoid replacing non-defective parts, try to find and isolate the problem.

For example, if you replace batteries and the problem remains, put the original batteries back and move to the next step.

Keep a record of the steps you take when troubleshooting. The information may be useful for reference when calling technical support or for bringing the Qumi to service personnel.



LED Error Messages

| ERROR CODE MESSAGES | POWER BLUE BLINK | TEMP BLUE BLINK |
|-------------------------------------|------------------|-----------------|
| Over temperature error (Inlet air) | - | ON |
| LED over temperature (Red) | - | 1 |
| LED over temperature (Green) | - | 2 |
| Fan 1 (Power) error | 6 | 1 |
| Fan 2 (System) error | 6 | 2 |
| Fan 3 (LED) error | 6 | 3 |
| Red LED Thermistor error | 8 | 1 |
| Green LED HSK Thermistor error | 8 | 2 |

In the event of an LED error, disconnect the AC power cord and wait for one (1) minute before restarting the Qumi.

If there is any other situation that isn't listed in the chart above, please contact your service center.

Image Problems

Problem: No image appears on the screen

1. Verify that the settings on your personal computer are properly configured.
2. Turn off all of the equipment and power up the equipment again in the correct order.

Problem: The image is blurred

1. Adjust the Focus on the Qumi.
2. Make sure the Qumi-to-screen distance is within the specified range.
3. Clean the Qumi lens with optical lens cleaning cloth if it is dirty.

Problem: The image is wider at the top or bottom (trapezoid effect)

1. Position the Qumi so that it is perpendicular to the screen as much as possible.
2. Adjust the Keystone settings in the OSD to correct the problem or set Auto Keystone to On.

Problem: The image is reversed

Check the orientation of the Projection setting in the Settings 1 menu in the OSD.

Problem: The image is streaked

1. Set the Frequency and Tracking settings on the Computer menu in the OSD to the default settings.
2. Connect the Qumi to another computer to make sure that the problem is not caused by a computer's video card.



Problem: The image is flat with no contrast

Adjust the Contrast setting in the Image menu in the OSD.

Problem: The color of the projected image does not match the source image

Adjust the Color Temperature and Gamma settings in the Image menu in the OSD.

Remote Control Problems

Problem: The Qumi does not respond to the remote control

1. Aim the remote control towards remote sensor on the Qumi.
2. Make sure the path between remote and sensor is not obstructed.
3. Turn off any fluorescent lights in the room.
4. Check to see if the battery polarity is correct.
5. Replace the batteries.
6. Turn off other Infrared-enabled devices in the vicinity.
7. Have the remote control serviced.

Audio Problems

Problem: There is no sound

1. Adjust the volume of the audio source.
2. Check the audio cable connection.
3. Test the output of the audio source with other speakers.
4. Have the Qumi serviced.

Problem: The sound is distorted

1. Check the audio cable connection.
2. Test the output of the audio source with other speakers.
3. Have the Qumi serviced.



FAQs

1. Does Qumi work with a personal computer, notebook or netbook?

Yes. Use the provided VGA cable or HDMI cable. The Qumi can connect to a PC, notebook or netbook if they have an appropriate HDMI or VGA port. To play audio, a stereo audio cable is required to connect to the Qumi's audio port.

2. Is it possible to connect the Qumi to a game console, such as a Microsoft® Xbox or Sony® PS3?

Yes. The Qumi can be used to display content from an Xbox or PS3 console. This can be done by connecting the HDMI cable from the game console to the Qumi.

3. Can the Qumi project content from a television?

Watching television content can be done by connecting a cable box, digital set-top-box or satellite receiver because televisions are only able to produce images on its own screen. For example, if a cable box is used, it can be connected by an HDMI cable to the Qumi.

4. How can MHL connect to the Qumi?

Use support MHL cable to connect MHL device.

Please visit www.mhlconsortium.org/productlist/ for more information

5. How are images from a digital camera or a USB Flash Disc displayed?

Images and other content can be displayed by connecting the following devices to the Qumi:

- USB Flash Disc, hard drive, card reader
- Digital camera
- Smart phone
- Multimedia storage viewer

Once the devices are connected, images can be displayed by using the Qumi Media Suite.

6. Which cable is required to video devices to the Qumi?

Video devices can be connected to the Qumi by using an Audio/Video or HDMI cable if the devices contain the appropriate ports. To play audio, an RCA cable connected can also be connected to the Qumi.

7. What type of video formats does the Qumi support?

H.264, MPEG-4, VC-1, WMV9, DivX(Xvid), Real Video, AVS and MJPEG.

8. What type of audio formats does the Qumi support?

MP3 and WMA.

9. What type of document formats does the QUMI support?

Microsoft® Office 2003 and Microsoft® Office 2007 (Word, Excel®, PowerPoint®), Adobe® PDF and text files (txt).



10. What type of photo formats does the QUMI support?

JPEG, PNG and BMP.

11. How long will the LED light source in the Qumi last and can it be replaced?

The Qumi does not use a typical UHP lamp. It uses a set of Light Emitting Diodes (LED) to illuminate and project images. LED's have a greater lifespan than conventional lamps. Qumi LED's are estimated to last for approximately 30,000 hours. The lifespan of the LED depends on factors such as brightness, usage, environmental conditions. LED brightness can decrease over time. The LED module is not replaceable.

12. Why do I need to re-adjust the focus on my Qumi after it's powered up?

For the best picture quality, adjustment of the focus ring may be necessary once the operational temperature has been met.

Vivitek Support Site

Please visit www.vivitekcorp.com for more information, support and product registration.



Specifications

| | |
|--|--|
| MODEL | Qumi Q7 Series |
| RESOLUTION | HD (720p - 1280x800) |
| PROJECTION DISTANCE | 800mm ~ 3000mm (31.5" ~ 118.11") |
| PROJECTION SCREEN SIZE (DIAGONAL) | 762mm ~ 2718mm (30" ~ 107") |
| PROJECTION LENS | Manual focus and Zoom |
| THROW RATIO | 1.3/1.43 : 1 |
| VERTICAL KEYSTONE CORRECTION | +40 step = 30° -40 step = -30° |
| PROJECTION METHODS | Front, Rear, Desktop, Front-Ceiling, Rear-Ceiling |
| DATA COMPATIBILITY | VGA, SVGA, XGA, SXGA, SXGA+, UXGA, Mac |
| SDTV/EDTV/ HDTV | 480i, 480p, 720p, 1080i, 1080p |
| VIDEO COMPATIBILITY | HDTV (720p, 1080i/p), NTSC/NTSC 4.43, PAL (B/G/H/I/M/N/60), SECAM |
| SAFETY CERTIFICATION | FCC-B, UL, CCC, CE, C-Tick, KC, CB, PSE, NOM, PCT, PSB, RoHS, ICES-003(Canada) |
| OPERATION TEMPERATURE | 5° ~ 35°C |
| DIMENSIONS (WXHxD) | 238mm (9.37") x 40mm (1.57") x 180mm (7.09") |
| AC INPUT | AC Universal 100 - 240V |
| POWER CONSUMPTION | 150W, <0.5W (Standby Mode) |
| AUDIO SPEAKER | 2W speaker x 2 |
| INPUT TERMINALS | VGA x 1 |
| | Video x 1 |
| | Audio in x 1(L&R) |
| | HDMI x 2 (HDMI1 available for MHL function) |
| | USB type A x 1 |
| OUTPUT TERMINALS | 3.5mm earphone jack (volume control) x 1 |

Note:

For questions regarding product specifications, please contact your local distributor.



Projection Distance vs. Projection Size

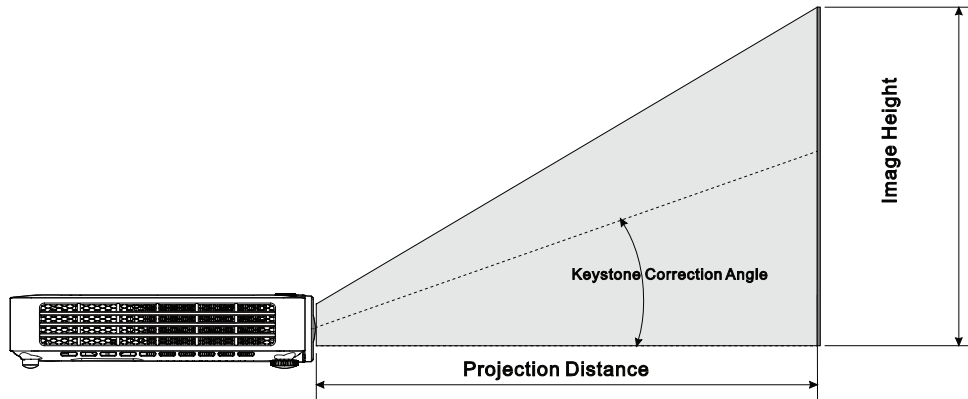

Projection Distance and Size Table

| IMAGE DIAGONAL (MM/INCHES) | IMAGE WIDTH (MM/INCHES) | IMAGE HIGH (MM/INCHES) | PROJECTION DISTANCE (MM/INCHES) |
|----------------------------|-------------------------|------------------------|---------------------------------|
| 762/30 | 646/25 | 404/16 | 840/33 |
| 1016/40 | 862/34 | 538/21 | 1120/44 |
| 1270/50 | 1077/42 | 673/26 | 1400/55 |
| 1524/60 | 1292/51 | 808/32 | 1680/66 |
| 1778/70 | 1508/59 | 942/37 | 1960/77 |
| 2032/80 | 1723/68 | 1077/42 | 2240/88 |
| 2286/90 | 1939/76 | 1212/48 | 2520/99 |
| 2540/100 | 2154/85 | 1346/53 | 2800/110 |
| 2794/110 | 2369/93 | 1481/58 | 3080/121 |



Timing Mode Table

| SIGNAL | RESOLUTION | H-SYNC (KHZ) | V-SYNC (HZ) | COMPOSITE / S-VIDEO | COMPONENT | RGB | DVI/HDMI |
|-------------|---------------------|--------------|-------------|---------------------|-----------|-----|----------|
| NTSC | — | 15.734 | 60.0 | O | — | — | — |
| PAL/SECAM | — | 15.625 | 50.0 | O | — | — | — |
| VESA | 720 x 400 | 37.9 | 85.0 | — | — | O | O |
| | 640 x 480 | 31.5 | 60.0 | — | — | O | O |
| | 640 x 480 | 37.9 | 72.8 | — | — | O | O |
| | 640 x 480 | 37.5 | 75.0 | — | — | O | O |
| | 640 x 480 | 43.3 | 85.0 | — | — | O | O |
| | 800 x 600 | 35.2 | 56.3 | — | — | O | O |
| | 800 x 600 | 37.9 | 60.3 | — | — | O | O |
| | 800 x 600 | 48.1 | 72.2 | — | — | O | O |
| | 800 x 600 | 46.9 | 75.0 | — | — | O | O |
| | 800 x 600 | 53.7 | 85.1 | — | — | O | O |
| | 800 x 600 (for 3D) | 76.3 | 120.0 | — | — | O | O |
| | 1024 x 768 | 48.4 | 60.0 | — | — | O | O |
| | 1024 x 768 | 56.5 | 70.1 | — | — | O | O |
| | 1024 x 768 | 60.0 | 75.0 | — | — | O | O |
| | 1024 x 768 | 68.7 | 85.0 | — | — | O | O |
| | 1024 x 768 (for 3D) | 97.6 | 120.0 | — | — | O | O |
| | 1280 x 760 | 45.0 | 60.0 | — | — | O | O |
| | 1280 x 720 (for 3D) | 91.5 | 119.9 | — | — | O | O |
| | 1280 x 800 | 49.7 | 59.8 | — | — | O | O |
| | 1280 x 800 | 62.8 | 74.9 | — | — | O | O |
| | 1280 x 800 | 71.6 | 84.8 | — | — | O | O |
| | 1280 x 1024 | 64.0 | 60.0 | — | — | O | O |
| | 1280 x 1024 | 80.0 | 75.0 | — | — | O | O |
| | 1280 x 1024 | 91.1 | 85.0 | — | — | O | O |
| 1400 x 1050 | 65.3 | 60.0 | — | — | O | O | |
| 1440 x 900 | 55.9 | 60.0 | — | — | O | O | |
| 1600 x 1200 | 75.0 | 60.0 | — | — | | | |
| 1920 x 1080 | 67.2 | 60.0 | — | — | O | O | |
| Apple® Mac | 640 x 480 | 35.0 | 66.68 | — | — | O | O |
| | 832 x 624 | 49.725 | 74.55 | — | — | O | O |
| | 1024 x 768 | 60.24 | 75.0 | — | — | O | O |
| | 1152 x 870 | 68.68 | 75.06 | — | — | O | O |
| SDTV | 480i | 15.734 | 60.0 | — | O | — | O |
| | 576i | 15.625 | 50.0 | — | O | — | O |



| | | | | | | | |
|------|-------|--------|------|---|---|---|---|
| EDTV | 480p | 31.469 | 60.0 | — | O | — | O |
| | 576p | 31.25 | 50.0 | — | O | — | O |
| HDTV | 720p | 37.5 | 50.0 | — | O | — | O |
| | 720p | 45.0 | 60.0 | — | O | — | O |
| | 1080i | 33.8 | 60.0 | — | O | — | O |
| | 1080i | 28.1 | 50.0 | — | O | — | O |
| | 1080p | 67.5 | 60.0 | — | O | — | O |
| | 1080p | 56.3 | 50.0 | — | O | — | O |

O: Frequency supported

—: Frequency not supported

*: Displayable level

2D→3D Timing Table

The unit automatically determines PC signals to select the appropriate resolution.

Some signals may require manual adjustment.

| SIGNAL | 2D RESOLUTION | H-SYNC (KHZ) | V-SYNC (HZ) | HDMI (DIGITAL) |
|--------|---------------|--------------|-------------|----------------|
| | 640 x 480 | 31.5 | 60 | O |
| | 800 x 600 | 37.9 | 60.3 | O |
| | 1024 x 768 | 48.4 | 60 | O |
| | 1280 x 720 | 45.0 | 60 | O |
| | 1280 x 768 | 47.8 | 60 | O |
| | 1280 x 800 | 49.7 | 60 | O |
| | 1280 x 1024 | 64 | 60 | O |
| | 1400 x 1050 | 65.3 | 60 | O |
| | 1440 x 900 | 55.9 | 60 | O |
| SDTV | 480i | 15.734 | 60 | O |
| | 576i | 15.625 | 50 | O |
| EDTV | 576p | 31.3 | 50 | O |
| | 480p | 31.5 | 60 | O |
| HDTV | 720p | 37.5 | 50 | O |
| | 720p | 45 | 60 | O |
| | 1080i | 33.8 | 60 | O |
| | 1080i | 28.1 | 50 | O |
| | 1080p | 67.5 | 60 | O |
| | 1080p | 56.3 | 50 | O |

O: Frequency supported

3D Timing Table

The unit automatically determines PC signals to select the appropriate resolution.

Some signals may require manual adjustment.

| 3D RESOLUTION | HDMI | 3D FORMAT |
|--------------------|------|------------------|
| 800 x 600 @ 120Hz | O | Frame sequential |
| 1024 x 768 @ 120Hz | O | Frame sequential |
| 1280 x 720 @ 120Hz | O | Frame sequential |
| HD 1080p 24 FPS | O | Frame packing |
| SD 720p 60 FPS | O | Frame packing |
| SD 720p 50 FPS | O | Frame packing |
| HD 1080i 50 SBSH | O | Side-by-side |
| SD 720p 60 SBSH | O | Side-by-side |
| SD 720p 50 SBSH | O | Side-by-side |

O: Frequency supported



Qumi Dimensions

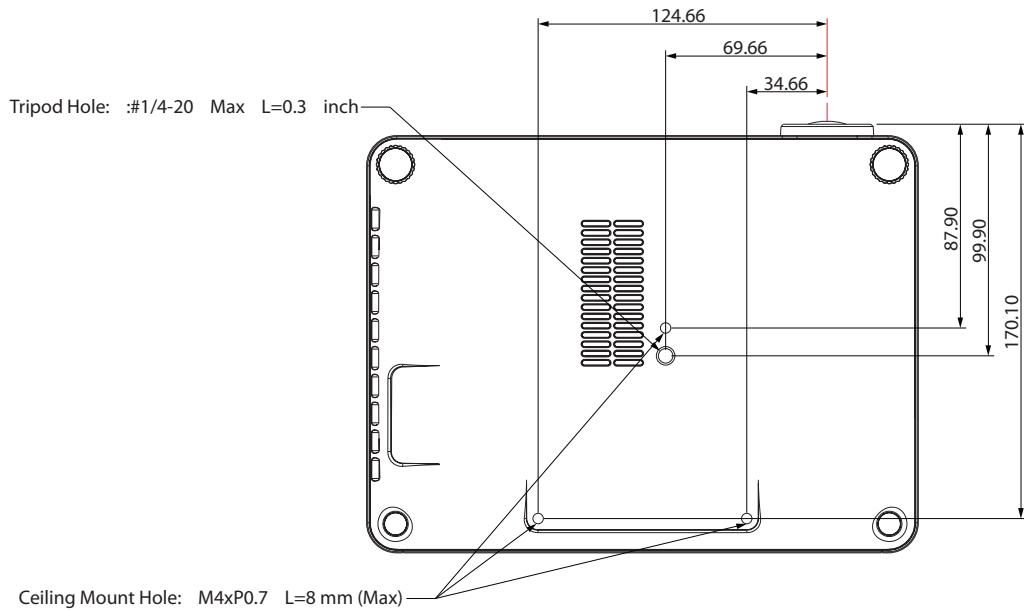
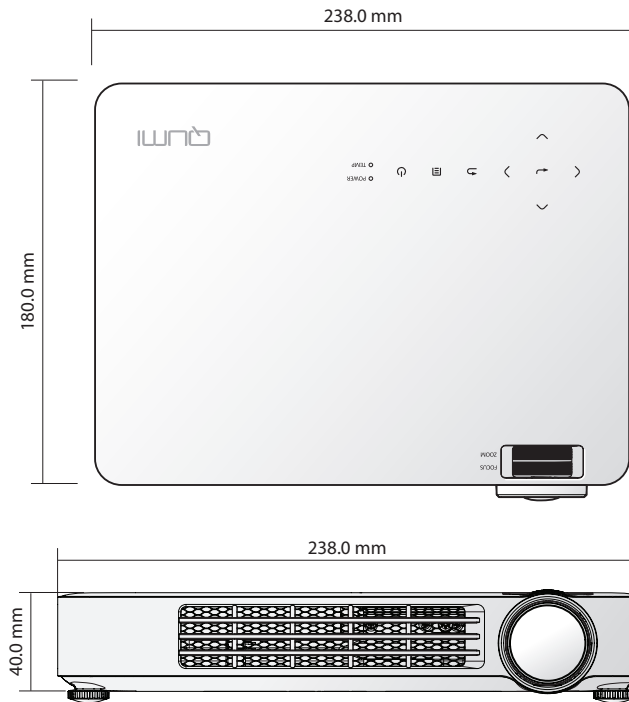

Note:
 When installing, ensure that you use only UL Listed ceiling mounts.
 For ceiling installations, use approved mounting hardware and M4 screws with a maximum screw depth of 8 mm (0.31 inch).
 The construction of the ceiling mount must be of a suitable shape and strength. The ceiling mount load capacity must exceed the weight of the installed equipment, and as an additional precaution be capable of withstanding three times the weight of the equipment (not less than 5.15 kg) over a period of 60 seconds.
 Do not cover the cooling vent.

Regulatory Compliance

FCC Warning

This equipment has been tested and found to comply with the limits for a Class B digital device pursuant to Part 15 of the FCC Rules. These limits are designed to provide reasonable protection against harmful interference when the equipment is operated in a commercial environment.

This equipment generates, uses, and can radiate radio frequency energy and, if not installed and used in accordance with the instruction manual, may cause harmful interference to radio communications. Operation of this equipment in a residential area is likely to cause harmful interference in which case the user will be required to correct the interference at his/her own expense.

Changes or modifications not expressly approved by the parties responsible for compliance could void the user's authority to operate the equipment.

Canada

This class B digital apparatus complies with Canadian ICES-003.

Safety Certifications

FCC-B, UL, CCC, CE, C-Tick, KC, CB, PSE, NOM, PCT, PSB, RoHS, ICES-003 (Canada)

Disposal and Recycling

This product may contain other electronic waste that can be hazardous if not disposed of properly. Recycle or dispose in accordance with local, state, or federal Laws. For more information, contact the Electronic Industries Alliance at www.eiae.org.

